

Termination connector, M12, male, straight, 4 poles

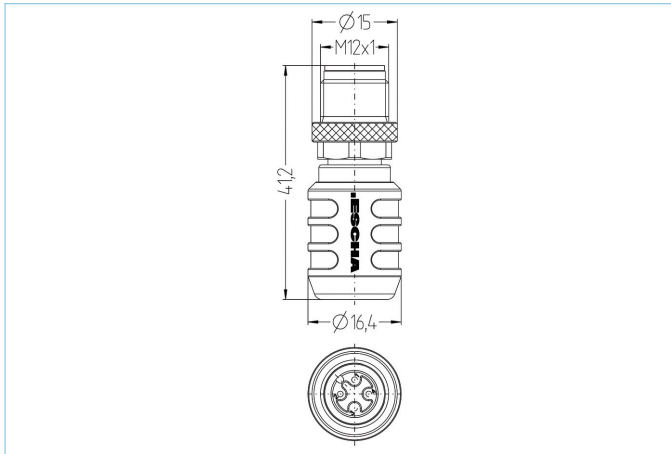

Product data

Item description	AL-WAS4.168-AS
Item-No.	8115898
Customs tariff-No.	85366990
Step-File	AL-WAS4-AS.stp
EAN	4047106320508

Technical data

Connector	male, straight, M12
Number of pins	4
Coding	A
Rated voltage	250V
Current load per pin (at 40°C)	4A
Insulation resistance	≥10 ⁹ Ω
Ambient temperature product	-30°C...+90°C
Contact material	Metal, CuZn, gold-plated
Contact-carrier material	Plastic, TPU, BK
Grip body material	Plastic, TPU, BK
Coupling nut material	Metal, CuZn, nickel-plated
Shielding	without shielding
Standards	IEC 61076-2-104
Degree of protection (mounted)	IP65, IP67, IP68
Mechanical life-cycle	>100 mating cycles
Degree of pollution	3
Style	straight

Classification

eCl@ss 6.0	19070403
eCl@ss 7.0	19070403
eCl@ss 8.0	19070403
eCl@ss 9.0	19070403
ETIM 5.0	EC000448
ETIM 6.0	EC000448