

ET, female, straight, 4 poles, ET, male, straight, 4 poles, Mobile Automation

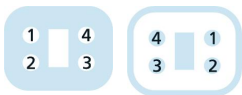
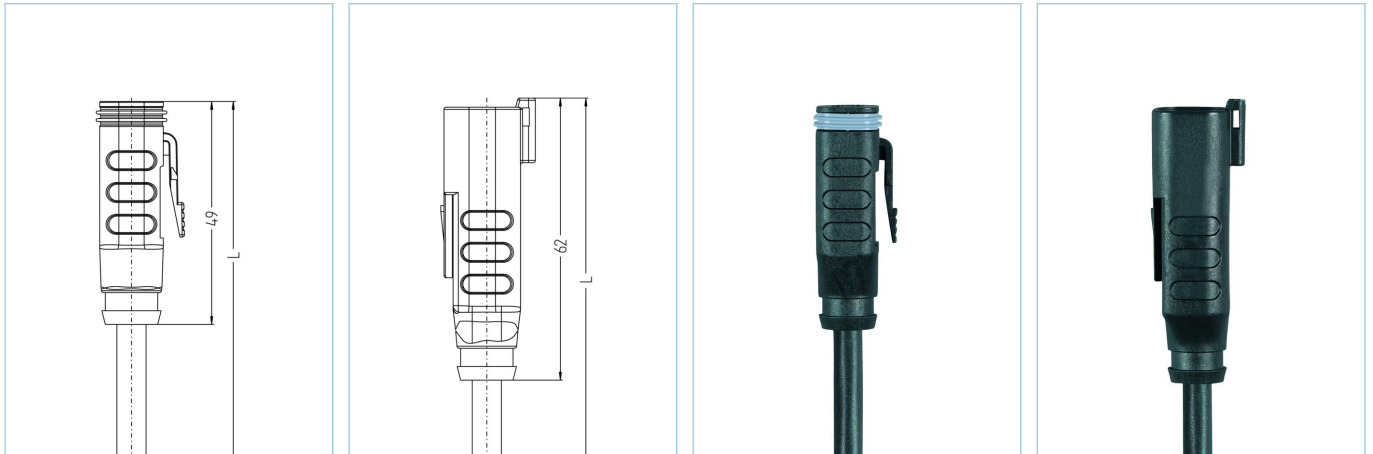

Product data

Item description	MA-ET06-4S-5-MA-ET04-4P/S370
Item-No.	8109208
Length	5m
Customs tariff-No.	85444290
Step-File	MA-ET06-4S-m-MA-ET04-4Pstp
EAN	4047106302795

Technical data	A-side	B-side
Connector	male, straight, ET	female, straight, ET
Number of pins	4	4
Pin assignment	1 BN, 2 BU, 3 BK, 4 WH	1 BN, 2 BU, 3 BK, 4 WH
Rated voltage	250V	250V
Current load (at 40°C)	7.5A	7.5A
Insulation resistance	$\geq 10^9 \Omega$	$\geq 10^9 \Omega$
Ambient temperature product	-40°C...+90°C	-40°C...+90°C
Contact material	Metal, CuZn, nickel-plated	Metal, CuZn, nickel-plated
Grip body material	Plastic, TPU, BK	Plastic, TPU, BK
Sealing (female) material	silicone	
Locking	Snap lock	Snap lock
Degree of protection (mounted)	IP67, IP68, IP69	IP67, IP68, IP69
Mechanical life-cycle	>100 mating cycles	>100 mating cycles
Degree of pollution	3	3

Cable web	PUR, UL, S370
------------------	----------------------

Flexible, silicone- and halogen-free control line with high mechanical strength. The cable is chemicals, hydrolysis-, and microbes- resistant. The drag-chain application is possible at a bending radius of minimum 10 x d. Due to its weld-field immunity, the cable is very well suited for the flexible application in robotics, machine-tool, and metal-cutting production. The cables meet the UL and CSA (UL10493/20549; cULus) requirements.

Outer diameter of jacket	6.40 mm
Cable-jacket material	PUR
Jacket color	BK, similar RAL9005
Wire cross-section	4 x 0.75 mm ²
Wire insulation material	PP
Wire colors	BN, BU, BK, WH
Bending radius (fixed)	5 x Ø-cable
Bending radius (repeated)	10 x Ø-cable
Temperature range (repeated)	-30°C...+90°C
Temperature range (fixed)	-40°C...+90°C
Temperature range (drag chain)	-25°C...+60°C
Drag chain-application	2 Mio. cycles
Halogen-free	Yes
Torsion	+/-180°/m, ≥ 500.000 cycles
Rated voltage cable	≤300 V
Special features	flame retardant, halogen free, hydrolysis proof, LABS free, oil resistant, ozone resistant, recyclable, RoHs compliant, acid- and alkali resistant, drag chain-adapted, welding sparks resistant, seawater resistant, silicone free, torsion resistant, UV resistant

Classification	
-----------------------	--

eCl@ss 6.0	27279200
eCl@ss 7.0	27279218
eCl@ss 8.0	27279218
eCl@ss 9.0	27060311
ETIM 5.0	EC001855
ETIM 6.0	EC001855

Accessories

Marking rings Ø 9mm
<https://www.escha.net/en/products/standard/accessories-for-connectivity?p=1&o=3&n=15&f=809>

Link to product

<https://www.escha.net/en/8109208>