

M12, male, angled, 4 poles, D-coded, M12, male, straight, 4 poles, D-coded, shielded, Industrial Ethernet 100 MBit/s

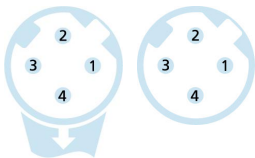
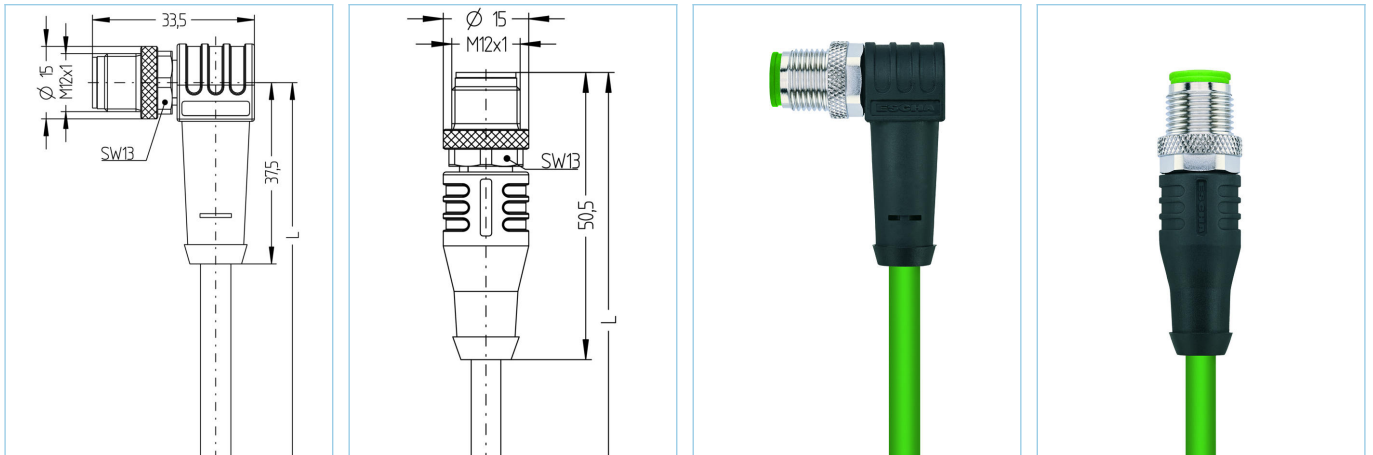

Product data

Item description	IE-WWASSY4.029-1-IE-WASSY4.029/S5200
Item-No.	8101290
Length	1m
Customs tariff-No.	85444290
Step-File	IE-WWASSY4_029-L-IE-WASSY4_029.stp
EAN	4047106284473
Label-carrier	2 pieces

Technical data	A-side	B-side
Connector	male, angled, M12	male, straight, M12
Number of pins	4	4
Pin assignment	1 YE, 2 WH, 3 OG, 4 BU	1 YE, 2 WH, 3 OG, 4 BU
Coding of	D	D
Rated voltage	60V	60V
Current load (at 40°C)	4A	4A
Insulation resistance	$\geq 10^9 \Omega$	$\geq 10^9 \Omega$
Resistance	$\leq 5m\Omega$	$\leq 5m\Omega$
Transmission features	Cat5e	Cat5e
Ambient temperature product	-30°C...+90°C	-30°C...+90°C
Contact material	Metal, CuSn, gold-plated	Metal, CuSn, gold-plated
Contact-carrier material	Plastic, TPU, GN	Plastic, TPU, GN
Grip body material	Plastic, TPU, BK	Plastic, TPU, BK
Coupling nut material	Metal, CuZn, nickel-plated	Metal, CuZn, nickel-plated
Shielding	with shielding	with shielding
Standards	IEC 61076-2-101	IEC 61076-2-101
Degree of protection (mounted)	IP65, IP67, IP68	IP65, IP67, IP68
Mechanical life-cycle	>100 mating cycles	>100 mating cycles
Degree of pollution	3	3

Advanced technical data UL

Rated voltage 30V

Cable web Cat5e, PVC, UL, S5200, PROFINET

Shielded, PVC-cable for industrial applications. The cable is AWM-Style 21694 verified or meets the Cat5e (electrical properties of EN 50288-2-1) requirements.

Outer diameter of jacket	6.50 mm
Cable-jacket material	PVC
Jacket color	GN, similar RAL6018
Wire cross-section	1 x 4 x AWG22, star quad
Wire insulation material	PVC
Wire colors	WH, BU, OG, YE
Wire structure	7 x 0.25 mm
Bending radius (fixed)	3 x Ø-cable
Bending radius (repeated)	7 x Ø-cable
Temperature range (repeated)	-40°C...+80°C
Temperature range (fixed)	-20°C...+60°C
Shielding	with shielding
Halogen-free	No
UL AWM style	UL AWM 21694
Transmission features	Cat5e
Rated voltage cable	600 V UL rating
Special features	flame retardant, high flexibility, microbes resistant, oil resistant, oil- and fuel resistant, ozone resistant, PROFINET Type B, recyclable, RoHs compliant, acid- and alkali resistant, seawater resistant, UV resistant

Classification

eCl@ss 6.0	27060307
eCl@ss 7.0	27060307
eCl@ss 8.0	27060307
eCl@ss 9.0	27060307
ETIM 5.0	EC000830
ETIM 6.0	EC000830

Link to product

<https://www.escha.net/en/products/standard/data-connectors/8101290>