

## M8, female, angled, 3 poles, with LED, sensor-/actuator cable

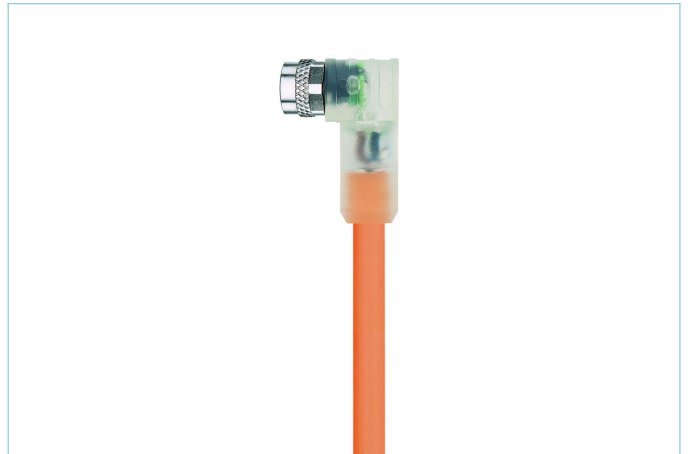
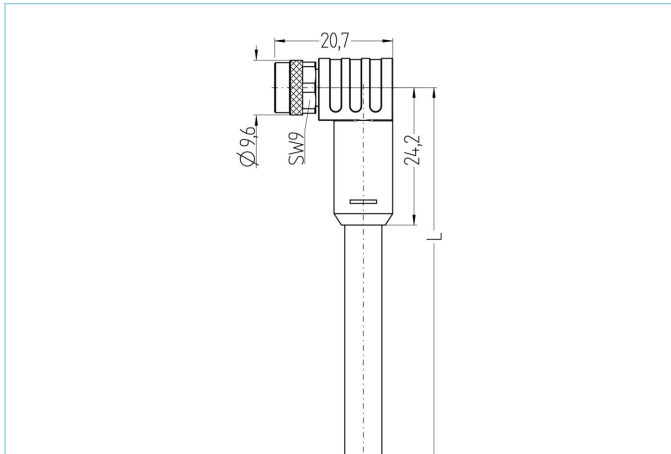

### Product data

Item description	AL-SWKP3P2-2/S740/S77
Item-No.	8094225
Length	2m
Customs tariff-No.	85444290
Step-File	AL-SWKP3P2.stp
EAN	4047106268220

### Technical data

Connector	female, angled, M8, with LED
Number of pins	3
Pin assignment	1 BN, 3 BU, 4 BK
Rated voltage	30V
Current load per pin (at 40°C)	3A
Insulation resistance	$\geq 10^9 \Omega$
Resistance	$\leq 5 m\Omega$
Ambient temperature product	-30°C...+90°C
Circuit logic	npn
Signal status-indicator	LED YE
Operating voltage-indicator	LED GN
Contact material	Metal, CuZn, gold-plated
Contact-carrier material	Plastic, TPU, BK
Grip body material	Plastic, TPU, transparent
Coupling nut material	Metal, CuZn, nickel-plated
Sealing (female) material	FPM/FKM

Standards	IEC 61076-2-104
Degree of protection (mounted)	IP65, IP67, IP68
Mechanical life-cycle	>100 mating cycles
Cable end assembly	open cable end
Degree of pollution	3
Style	angled

<b>Cable web</b>	<b>PUR, UL, S740, welding sparks resistant, Automotive</b>
------------------	--

Flexible, silicone- and halogen free control cable with high mechanical strength. Due to its outstanding properties in drag-chain adaption, torsionresistance and weld-field immunity, it is very well suited for the flexible applications in robotics, handling- and assembly technology as well as machine tools. The cable meets the UL and CSA (UL10493/20549; cULus) requirements.

Outer diameter of jacket	6.2 mm
Cable-jacket material	PUR
Jacket color	OG, similar RAL2003
Wire cross-section	3 x 0.34 mm <sup>2</sup>
Wire insulation material	PP
Wire colors	BN, BU, BK
Wire structure	42 x 0.10 mm
Bending radius (fixed)	5 x Ø-cable
Bending radius (repeated)	10 x Ø-cable
Temperature range (repeated)	-30°C...+90°C
Temperature range (fixed)	-40°C...+90°C
Temperature range (drag chain)	-25°C...+60°C
Drag chain-application	5 Mio. cycles
Halogen-free	Yes
Torsion	+/-360°/m, ≥ 2 Mio. cycles
Rated voltage cable	≤300 V
Special features	flame retardant, halogen free, hydrolysis proof, LABS free, oil resistant, ozone resistant, recyclable, RoHs compliant, acid- and alkali resistant, drag chain-adapted, welding sparks resistant, seawater resistant, silicone free, torsion resistant, UV resistant

Eigenschaften Automotiv	The cable meets the requirements of MgU-I-B09-41 for sensor-/ actuator cables for the body shop area.
-------------------------	---

### Classification

eCl@ss 6.0	27279218
eCl@ss 7.0	27279218
eCl@ss 8.0	27279218
eCl@ss 9.0	27060311
ETIM 5.0	EC001855
ETIM 6.0	EC001855

### Accessories

#### Mounting-clip, M8

<https://www.escha.net/en/products/standard/accessories-for-connectivity/8047658>

#### Torque-wrench set

<https://www.escha.net/en/products/standard/accessories-for-connectivity/8055431>

#### Marking rings Ø 9mm

<https://www.escha.net/en/products/standard/accessories-for-connectivity?p=1&o=3&n=15&f=809>

#### Screw plug, M8

<https://www.escha.net/en/products/standard/accessories-for-connectivity/8081771>

#### Cable Stripping Tool

<https://www.escha.net/en/products/standard/accessories-for-connectivity/8066215>

#### Cable Stripping Tool

<https://www.escha.net/en/products/standard/accessories-for-connectivity/8066216>

**Link to product**

<https://www.escha.net/en/products/standard/sensoractuator-connectors/8094225>