

M12, female, straight, 5 poles, M12, male, straight, 5 poles, sensor-/actuator cable

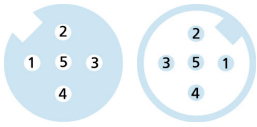
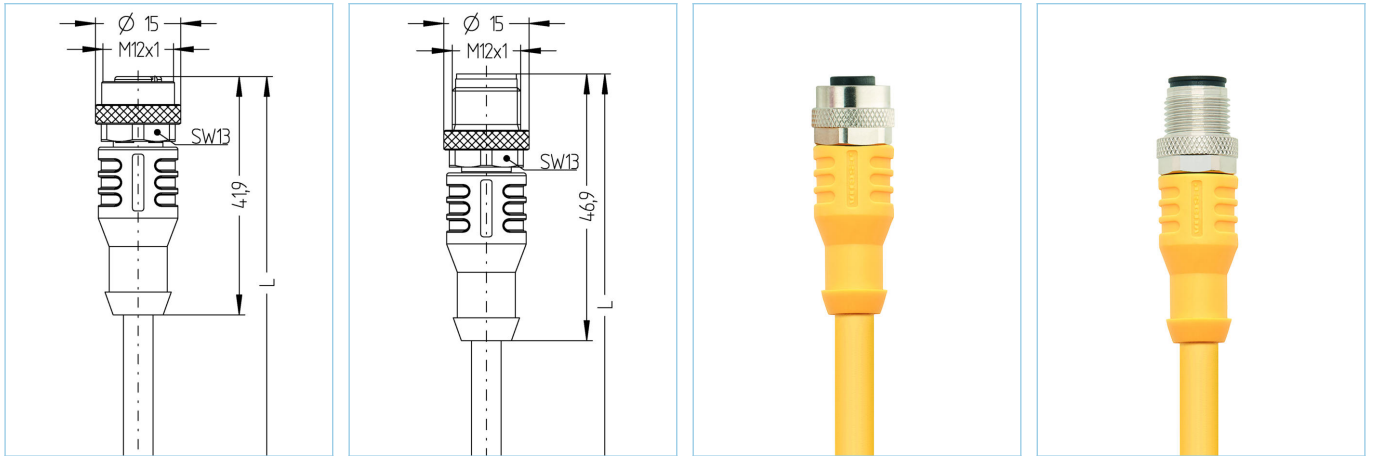

Product data	
Item description	AL-WAK4.5-2-AL-WAS4.5/S740YE/S600
Item-No.	8092653
Length	2m
Customs tariff-No.	85444290
Step-File	AL-WAK4_5-AL-WAS4_5.stp
EAN	4047106278496

Technical data	A-side	B-side
Connector	female, straight, M12	male, straight, M12
Number of pins	5	5
Pin assignment	1 BN, 2 WH, 3 BU, 4 BK, 5 GY	1 BN, 2 WH, 3 BU, 4 BK, 5 GY
Coding of	A	A
Rated voltage	60V	60V
Current load (at 40°C)	4A	4A
Insulation resistance	$\geq 10^9 \Omega$	$\geq 10^9 \Omega$
Resistance	$\leq 5 m\Omega$	$\leq 5 m\Omega$
Ambient temperature product	-30°C...+90°C	-30°C...+90°C
Contact material	Metal, CuSn, gold-plated	Metal, CuSn, gold-plated
Contact-carrier material	Plastic, TPU, BK	Plastic, TPU, BK
Grip body material	Plastic, TPU, BK	Plastic, TPU, BK
Coupling nut material	Metal, CuZn, nickel-plated	Metal, CuZn, nickel-plated
Sealing (female) material	FPM/FKM	
Standards	IEC 61076-2-101	IEC 61076-2-101
Degree of protection (mounted)	IP65, IP67, IP68	IP65, IP67, IP68
Mechanical life-cycle	>100 mating cycles	>100 mating cycles
Degree of pollution	3	3

Cable web PUR, UL, S740YE, welding sparks resistant, Automotive

Flexible, silicone- and halogen free control cable with high mechanical strength. Due to its outstanding properties in drag-chain adaption, torsionresistance and weld-field immunity, it is very well suited for the flexible applications in robotics, handling- and assembly technology as well as machine tools. The cable meets the UL and CSA (UL10493/20549; cULus) requirements.

Outer diameter of jacket	7.0 mm
Cable-jacket material	PUR
Jacket color	YE, similar RAL 1018
Wire cross-section	5 x 0.34 mm ²
Wire insulation material	PP
Wire colors	BN, WH, BU, BK, GY
Wire structure	42 x 0.10 mm
Bending radius (fixed)	5 x Ø-cable
Bending radius (repeated)	10 x Ø-cable
Temperature range (repeated)	-30°C...+90°C
Temperature range (fixed)	-40°C...+90°C
Temperature range (drag chain)	-25°C...+60°C
Drag chain-application	3 Mio. cycles
Halogen-free	Yes
Torsion	+/-180°/m, ≥ 1 Mio. cycles
Rated voltage cable	≤300 V
Special features	flame retardant, halogen free, hydrolysis proof, LABS free, oil resistant, ozone resistant, recyclable, RoHs compliant, acid- and alkali resistant, drag chain-adapted, welding sparks resistant, seawater resistant, silicone free, torsion resistant, UV resistant
Eigenschaften Automotiv	The cable meets the requirements of MgU-I-B09-41 for sensor-/ actuator cables for the body shop area.

Classification

eCl@ss 6.0	27279218
eCl@ss 7.0	27279218
eCl@ss 8.0	27279218
eCl@ss 9.0	27060311
ETIM 5.0	EC001855
ETIM 6.0	EC001855

Accessories
Mounting-clip, M12

<https://www.escha.net/en/products/standard/accessories-for-connectivity/8047660>

Torque-wrench set

<https://www.escha.net/en/products/standard/accessories-for-connectivity/8055431>

Marking rings Ø 9mm

<https://www.escha.net/en/products/standard/accessories-for-connectivity?p=1&o=3&n=15&f=809>

Screw plug, M12

<https://www.escha.net/en/products/standard/accessories-for-connectivity?p=1&o=3&n=15&f=812>

Screw cap, M12

<https://www.escha.net/en/products/standard/accessories-for-connectivity?p=1&o=3&n=15&f=811>

Link to product

<https://www.escha.net/en/products/standard/sensoractuator-connectors/8092653>