

M8, female, straight, 4 poles, D-coded, M8, male, straight, 4 poles, D-coded, shielded, Industrial Ethernet

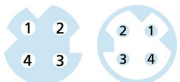

PROFI
NET

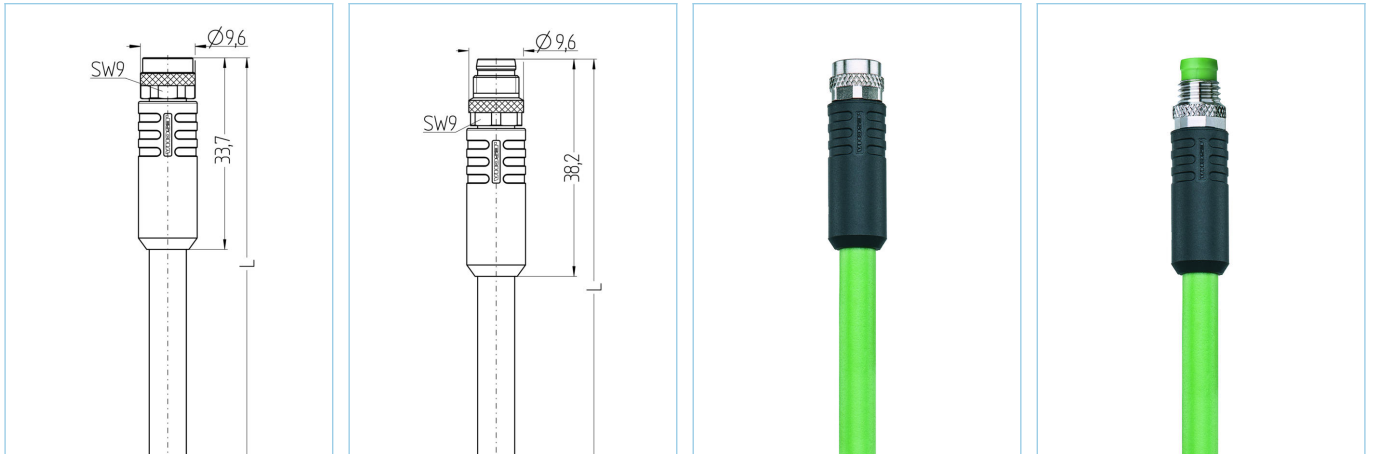

Product data

Item description	IE-SKPSD4.073-5-IE-SSPSD4.073/S5100
Item-No.	8092584
Length	5m
Customs tariff-No.	85444290
Step-File	IE-SKPSD4-m-IE-SSPSD4_S2171.stp
EAN	4047106258665
Label-carrier	2 pieces

Technical data	A-side	B-side
Connector	female, straight, M8	male, straight, M8
Number of pins	4	4
Pin assignment	1 YE, 2 WH, 3 OG, 4 BU	1 YE, 2 WH, 3 OG, 4 BU
Coding of	D	D
Rated voltage	50V _{AC} 60V _{DC}	50V _{AC} 60V _{DC}
Current load (at 40°C)	4A	4A
Insulation resistance	≥10 ⁹ Ω	≥10 ⁹ Ω
Transmission features	Cat5e	Cat5e
Ambient temperature product	-30°C...+90°C	-30°C...+90°C
Contact material	Metal, CuSn, gold-plated	Metal, CuSn, gold-plated
Contact-carrier material	Plastic, TPU, GN	Plastic, TPU, GN
Grip body material	Plastic, TPU, BK	Plastic, TPU, BK
Coupling nut material	Metal, CuZn, nickel-plated	Metal, CuZn, nickel-plated
Sealing (female) material	FPM/FKM	
Shielding	with shielding	with shielding
Standards	IEC 61076-2-114	IEC 61076-2-114
Degree of protection (mounted)	IP65, IP67, IP68	IP65, IP67, IP68
Mechanical life-cycle	>100 mating cycles	>100 mating cycles
Degree of pollution	3	3

Cable web

Cat5e, PUR, UL, S5100, PROFINET Type R

Shielded, PUR-cable for industrial applications. The cable is UL-verified or meets the Cat5e (electrical properties of EN 50288-2-1) requirements. Materials and a constructive setup allow for increased mechanical stresses (abrasion, bending, vibrations etc.) of the cable. This cable is especially suitable for robotic applications.

Outer diameter of jacket	6.50 mm
Cable-jacket material	PUR
Jacket color	GN, similar RAL6018
Wire cross-section	1 x 4 x AWG22, star quad
Wire insulation material	PE
Wire colors	YE/OG ; WH/BU
Wire structure	19 x 0.15 mm
Bending radius (fixed)	5 x Ø-cable
Bending radius (repeated)	10 x Ø-cable
Temperature range (repeated)	-20°C...+80°C
Temperature range (fixed)	-40°C...+80°C
Drag chain-application	5 Mio. bending cycles
Halogen-free	Yes
Torsion	>5 Mio. cycles
Transmission features	Cat5e
Rated voltage cable	600 V UL rating
Special features	flame retardant, halogen free, high flexibility, hydrolysis proof, LABS free, microbes resistant, oil resistant, ozone resistant, PROFINET Type R, recyclable, RoHs compliant, acid- and alkali resistant, drag chain-adapted, seawater resistant, torsion resistant, UV resistant

Classification

eCl@ss 6.0	27060307
eCl@ss 7.0	27060307
eCl@ss 8.0	27060307
eCl@ss 9.0	27060307
ETIM 5.0	EC000830
ETIM 6.0	EC000830

Accessories

Mounting-clip, M8

<https://www.escha.net/en/products/standard/accessories-for-connectivity/8047658>

Torque-wrench set

<https://www.escha.net/en/products/standard/accessories-for-connectivity/8055431>

Marking rings Ø 9mm

<https://www.escha.net/en/products/standard/accessories-for-connectivity?p=1&o=3&n=15&f=809>

Screw plug, M8

<https://www.escha.net/en/products/standard/accessories-for-connectivity/8081771>

Screw cap, M8

<https://www.escha.net/en/products/standard/accessories-for-connectivity/8081761>

Link to product

<https://www.escha.net/en/products/standard/data-connectors/8092584>