

M12, female, angled, 8 poles, M12, male, straight, 8 poles, sensor-/actuator cable

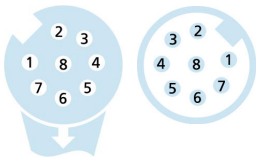
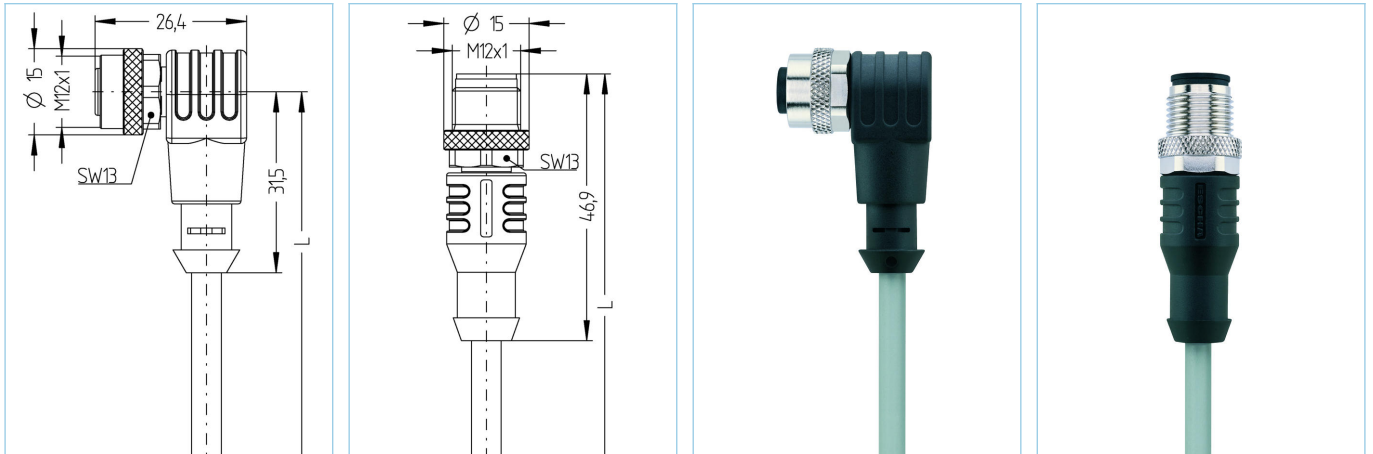

Product data

Item description	AL-WWAK8-5-AL-WAS8/S370GY
Item-No.	8092351
Length	5m
Customs tariff-No.	85444290
Step-File	AL-WWAK8_AL-WAS8.stp
EAN	4047106263812

Technical data

	A-side	B-side
Connector	female, angled, M12	male, straight, M12
Number of pins	8	8
Pin assignment	1 WH, 2 BN, 3 GN, 4 YE, 5 GY, 6 PK, 7 BU, 8 RD	1 WH, 2 BN, 3 GN, 4 YE, 5 GY, 6 PK, 7 BU, 8 RD
Coding of	A	A
Rated voltage	30V	30V
Current load (at 40°C)	2A	2A
Insulation resistance	$\geq 10^9 \Omega$	$\geq 10^9 \Omega$
Resistance	$\leq 5 m\Omega$	$\leq 5 m\Omega$
Ambient temperature product	-30°C...+90°C	-30°C...+90°C
Contact material	Metal, CuZn, gold-plated	Metal, CuZn, gold-plated
Contact-carrier material	Plastic, TPU, BK	Plastic, TPU, BK
Grip body material	Plastic, TPU, BK	Plastic, TPU, BK
Coupling nut material	Metal, CuZn, nickel-plated	Metal, CuZn, nickel-plated
Sealing (female) material	FPM/FKM	
Standards	IEC 61076-2-101	IEC 61076-2-101
Degree of protection (mounted)	IP65, IP67, IP68	IP65, IP67, IP68
Mechanical life-cycle	>100 mating cycles	>100 mating cycles
Degree of pollution	3	3

Cable web	PUR, UL, S370GY
------------------	------------------------

Flexible, silicone- and halogen-free control line with high mechanical strength. The cable is chemicals, hydrolysis-, and microbes- resistant. The drag-chain application is possible at a bending radius of minimum 10 x d. Due to its weld-field immunity, the cable is very well suited for the flexible application in robotics, machine-tool, and metal-cutting production. The cables meet the UL and CSA (UL10493/20549; cULus) requirements.

Outer diameter of jacket	5.90 mm
Cable-jacket material	PUR
Jacket color	GY, similar RAL7040
Wire cross-section	8 x 0.25 mm ²
Wire insulation material	PP
Wire colors	WH, BN, GN, YE, GY, PK, BU, RD
Wire structure	32 x 0.10 mm
Bending radius (fixed)	5 x Ø-cable
Bending radius (repeated)	10 x Ø-cable
Temperature range (repeated)	-30°C...+90°C
Temperature range (fixed)	-40°C...+90°C
Temperature range (drag chain)	-25°C...+60°C
Drag chain-application	≥2 Mio. cycles
Halogen-free	Yes
Torsion	+/-180°/m, ≥ 0.5 Mio. cycles
Rated voltage cable	≤300 V
Special features	flame retardant, halogen free, hydrolysis proof, LABS free, oil resistant, ozone resistant, recyclable, RoHs compliant, acid- and alkali resistant, drag chain-adapted, welding sparks resistant, seawater resistant, silicone free, torsion resistant, UV resistant

Classification

eCl@ss 6.0	27279218
eCl@ss 7.0	27279218
eCl@ss 8.0	27279218
eCl@ss 9.0	27060311
ETIM 5.0	EC001855
ETIM 6.0	EC001855

Accessories

Mounting-clip, M12
<https://www.escha.net/en/products/standard/accessories-for-connectivity/8047660>

Torque-wrench set
<https://www.escha.net/en/products/standard/accessories-for-connectivity/8055431>

Marking rings Ø 9mm
<https://www.escha.net/en/products/standard/accessories-for-connectivity?p=1&o=3&n=15&f=809>

Screw plug, M12
<https://www.escha.net/en/products/standard/accessories-for-connectivity?p=1&o=3&n=15&f=812>

Screw cap, M12
<https://www.escha.net/en/products/standard/accessories-for-connectivity?p=1&o=3&n=15&f=811>

Link to product

<https://www.escha.net/en/products/standard/sensoractuator-connectors/8092351>