

M8, female, angled, 4 poles, P-coded, shielded, Industrial Ethernet

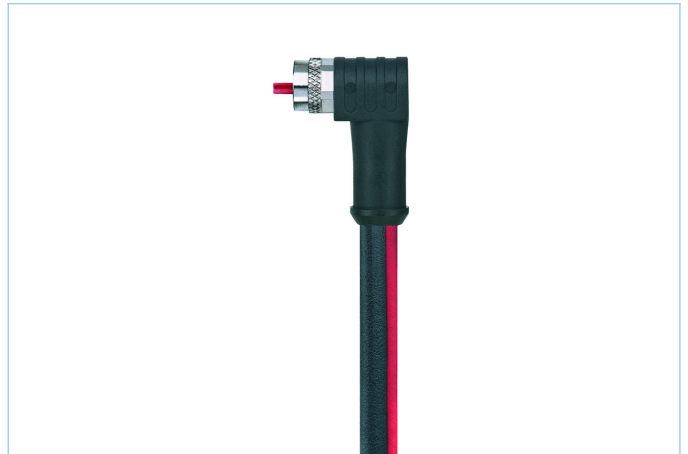

EtherCAT

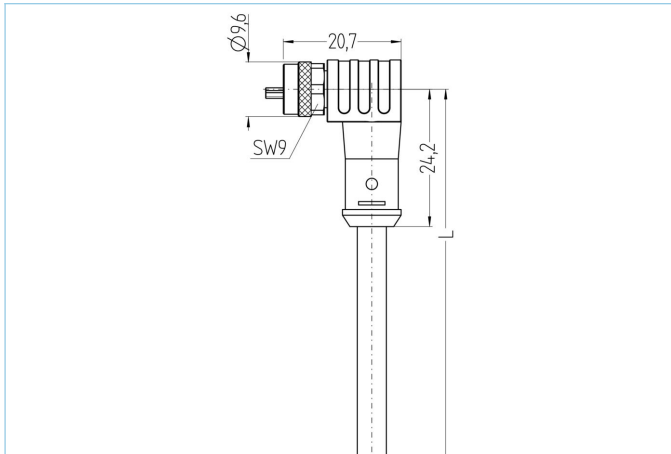

Product data

Item description	IE-SWKPSP4.054-10/S5059
Item-No.	8089152
Length	10m
Customs tariff-No.	85444290
Step-File	IE-SWKPSP4-m_S5059.stp
EAN	4047106253998

Technical data

Connector	female, angled, M8
Number of pins	4
Pin assignment	1 YE, 2 WH, 3 BU, 4 OG
Coding	P
Rated voltage	50V _{AC} 60V _{DC}
Current load per pin (at 40°C)	4A
Insulation resistance	≥10 ⁹ Ω
Resistance	≤ 5mΩ
Transmission features	Cat5e
Ambient temperature product	-30°C...+90°C
Contact material	Metal, CuZn, gold-plated
Contact-carrier material	Plastic, PA, BK
Grip body material	Plastic, TPU, BK
Coupling nut material	Metal, CuZn, nickel-plated
Shielding	with shielding
Standards	IEC 61076-2-104
Degree of protection (mounted)	IP65, IP67, IP68
Mechanical life-cycle	>100 mating cycles
Cable end assembly	open cable end
Degree of pollution	3/2
Style	angled

Cable web Cat5e, PUR, UL, S5059, EtherCAT P

Shielded, PUR-cable for EtherCAT P industrial applications. The cable is UL-verified or meets the Cat5e (electrical properties of EN 50288-2-1) requirements. Materials and a constructive setup allow for increased mechanical stresses (abrasion, bending, vibrations etc.) of the cable. A drag-chain application with up to 2 million bending cycles is possible.

Outer diameter of jacket	5.20 mm
Cable-jacket material	PUR
Jacket color	BK, with red vertical stripe
Wire cross-section	1 x 4 x AWG24, star quad
Wire insulation material	Foam-Skin Polyolefin
Wire colors	YE/OG ; WH/BU
Wire structure	7 x 0,22 mm
Bending radius (fixed)	8 x Ø-cable
Bending radius (repeated)	15 x Ø-cable
Temperature range (repeated)	-30°C...+70°C
Temperature range (fixed)	-40°C...+80°C
Drag chain-application	3 Mio. bending cycles
Halogen-free	Yes
Transmission features	Cat5e
Rated voltage cable	300 V
Special features	EtherCAT P compliant, flame retardant, halogen free, high flexibility, hydrolysis proof, LABS free, microbes resistant, oil resistant, ozone resistant, recyclable, RoHS compliant, acid- and alkali resistant, drag chain-adapted, seawater resistant, UN ECE R 118, UV resistant

Classification

eCl@ss 6.0	27060307
eCl@ss 7.0	27060307
eCl@ss 8.0	27060307
eCl@ss 9.0	27060307
ETIM 5.0	EC000830
ETIM 6.0	EC000830

Accessories

Mounting-clip, M8 https://www.escha.net/en/products/standard/accessories-for-connectivity/8047658
Torque-wrench set https://www.escha.net/en/products/standard/accessories-for-connectivity/8055431
Marking rings Ø 9mm https://www.escha.net/en/products/standard/accessories-for-connectivity?p=1&o=3&n=15&f=809
Screw plug, M8 https://www.escha.net/en/products/standard/accessories-for-connectivity/8081771
Cable Stripping Tool https://www.escha.net/en/products/standard/accessories-for-connectivity/8066215
Cable Stripping Tool https://www.escha.net/en/products/standard/accessories-for-connectivity/8066216

Link to product

<https://www.escha.net/en/products/standard/data-connectors/8089152>