

M8, female, straight, 4 poles, M8, male, angled, 4 poles, sensor-/actuator cable

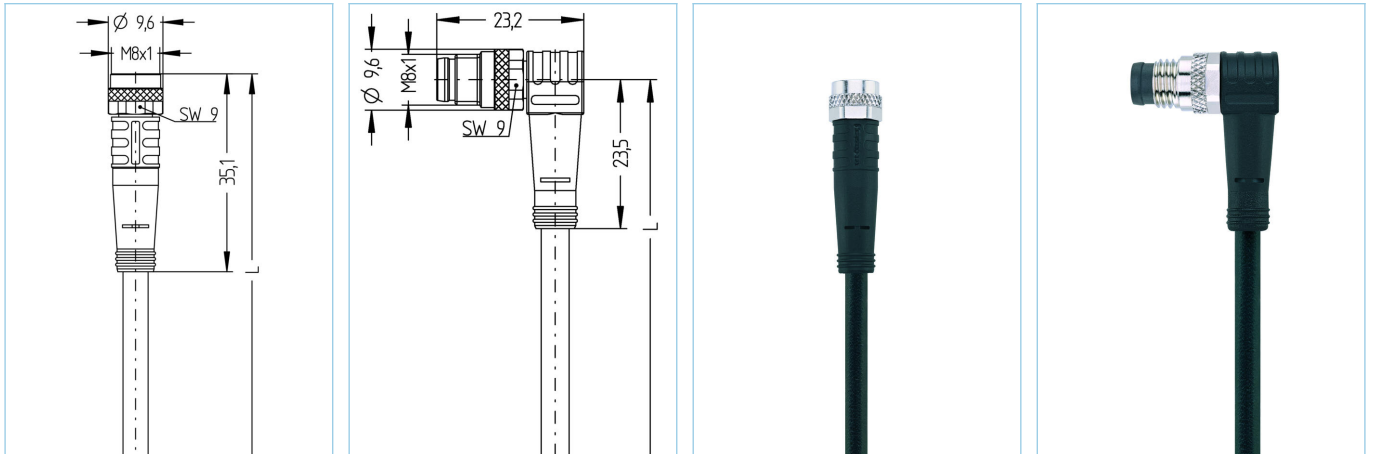

Product data

Item description	AL-SKP4-5-AL-SWSP4/P01BK
Item-No.	8081948
Length	5m
Customs tariff-No.	85444290
Step-File	AL-SKP4_AL-SWSP4.stp
EAN	4047106233785

Technical data

	A-side	B-side
Connector	female, straight, M8	male, angled, M8
Number of pins	4	4
Pin assignment	1 BN, 2 WH, 3 BU, 4BK	1 BN, 2 WH, 3 BU, 4BK
Rated voltage	60V	60V
Current load (at 40°C)	4A	4A
Insulation resistance	$\geq 10^9 \Omega$	$\geq 10^9 \Omega$
Resistance	$\leq 5 m\Omega$	$\leq 5 m\Omega$
Ambient temperature product	-30°C...+90°C	-30°C...+90°C
Contact material	Metal, CuSn, gold-plated	Metal, CuSn, gold-plated
Contact-carrier material	Plastic, TPU, BK	Plastic, TPU, BK
Grip body material	Plastic, TPU, BK	Plastic, TPU, BK
Coupling nut material	Metal, CuZn, nickel-plated	Metal, CuZn, nickel-plated
Sealing (female) material	FPM/FKM	
Standards	IEC 61076-2-104	IEC 61076-2-104
Degree of protection (mounted)	IP65, IP67, IP68	IP65, IP67, IP68
Mechanical life-cycle	>100 mating cycles	>100 mating cycles
Degree of pollution	3/2	3/2

<b>Cable web</b>	<b>PVC, P01BK, UL</b>
------------------	-----------------------

PVC-cable for measurement and control-, and sensor technology. Suitable for applications in dry areas on packaging machines, assembly- and conveyor technology. High flexibility with unstressed movement (conditional drag-chain application possible). Predestined for applications in food- and beverage industry.

Outer diameter of jacket	4.70 mm
Cable-jacket material	PVC
Jacket color	BK, similar RAL9005
Wire cross-section	4 x 0.25 mm <sup>2</sup>
Wire insulation material	PVC
Wire colors	BN, WH, BU, BK
Wire structure	14 x 0.15 mm
Bending radius (fixed)	5 x Ø-cable
Bending radius (repeated)	10 x Ø-cable
Temperature range (repeated)	0°C...+80°C
Temperature range (fixed)	-25°C...+80°C
Rated voltage cable	≤300 V
Special features	good resistance against oils and chemicals, LABS free, ozone resistant, recyclable, RoHs compliant, acid- and alkali resistant, seawater resistant, UV resistant

<b>Classification</b>	
-----------------------	--

eCl@ss 6.0	27279218
eCl@ss 7.0	27279218
eCl@ss 8.0	27279218
eCl@ss 9.0	27060311
ETIM 5.0	EC001855
ETIM 6.0	EC001855

<b>Accessories</b>	
--------------------	--

Mounting-clip, M8 <a href="https://www.escha.net/en/products/standard/accessories-for-connectivity/8047658">https://www.escha.net/en/products/standard/accessories-for-connectivity/8047658</a>	
Torque-wrench set <a href="https://www.escha.net/en/products/standard/accessories-for-connectivity/8055431">https://www.escha.net/en/products/standard/accessories-for-connectivity/8055431</a>	
Marking rings Ø 9mm <a href="https://www.escha.net/en/products/standard/accessories-for-connectivity?p=1&amp;o=3&amp;n=15&amp;f=809">https://www.escha.net/en/products/standard/accessories-for-connectivity?p=1&amp;o=3&amp;n=15&amp;f=809</a>	
Screw plug, M8 <a href="https://www.escha.net/en/products/standard/accessories-for-connectivity/8081771">https://www.escha.net/en/products/standard/accessories-for-connectivity/8081771</a>	
Screw cap, M8 <a href="https://www.escha.net/en/products/standard/accessories-for-connectivity/8081761">https://www.escha.net/en/products/standard/accessories-for-connectivity/8081761</a>	

<b>Link to product</b>	
------------------------	--

<a href="https://www.escha.net/en/products/standard/sensoractuator-connectors/8081948">https://www.escha.net/en/products/standard/sensoractuator-connectors/8081948</a>	
---	--