

RJ45, male, angled, 4 poles, shielded, Industrial Ethernet 100 MBit/s

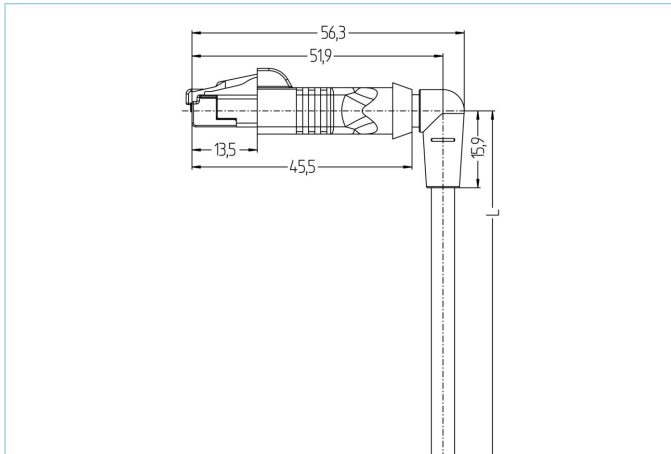

Product data

Item description	IE-W0RJ45SS8.005-10/S3400
Item-No.	8080678
Length	10m
Customs tariff-No.	85444290
Step-File	IE-W0RJ45SS8-m.stp
EAN	4047106231583

Technical data

Connector	male, angled, RJ45, 0°
Number of pins	4
Pin assignment	1 WHOG, 2 OG, 3 WHBU, 6 BU
Rated voltage	60V
Current load per pin (at 40°C)	1A
Insulation resistance	≥10 ⁹ Ω
Transmission features	Cat5e
Ambient temperature product	-40°C...+70°C
Contact material	Metal, CuSn, gold-plated
Contact-carrier material	Plastic, PA UL94-V0, transparent
Grip body material	Plastic, TPE, BK
Material of shielding housing	Metal, CuZn, nickel-plated
Shielding	with shielding
Standards	IEC 60603-7-5
Degree of protection (mounted)	IP20
Mechanical life-cycle	>750 mating cycles
Cable end assembly	open cable end
Degree of pollution	1
Style	angled

Cable web **Cat5e, PUR, UL, S3400**

Shielded PUR Ethernet-cable for industrial applications. Fits to real-time requirements according to IEC61158. The cable meets the UL-Style 21815 (80°/300V)- and the Cat5 (electrical properties according to EN50288-2-2) requirements. Materials and a constructive setup for increased mechanical stresses (abrasion, bending, vibrations etc.) of the cable. Drag-chain/torsion operations are possible. High tensile strength through incorporated Kevlar-strands.

Outer diameter of jacket	4.80 mm
Cable-jacket material	PUR
Jacket color	GN, similar RAL6018
Wire cross-section	1 x 4 x AWG26, star quad
Wire insulation material	PP
Wire colors	WHBU/BU, WHOG/OG
Wire structure	19 x 0.10 mm
Bending radius (fixed)	4 x Ø-cable
Bending radius (repeated)	7,5 x Ø-cable
Temperature range (repeated)	-30°C...+70°C
Temperature range (fixed)	-40°C...+80°C
Transmission features	Cat5
Rated voltage cable	300 V UL rating
Special features	halogen free, high flexibility, hydrolysis proof, LABS free, microbes resistant, oil resistant, ozone resistant, recyclable, RoHs compliant, acid- and alkali resistant, drag chain-adapted, seawater resistant, UV resistant

Classification

eCl@ss 6.0	27061801
eCl@ss 7.0	27060308
eCl@ss 8.0	27060308
eCl@ss 9.0	27060308
ETIM 5.0	EC002599
ETIM 6.0	EC002599

Link to product

<https://www.escha.net/en/products/standard/data-connectors/8080678>