

RJ45, male, angled, 4 poles, shielded, Industrial Ethernet 100 MBit/s

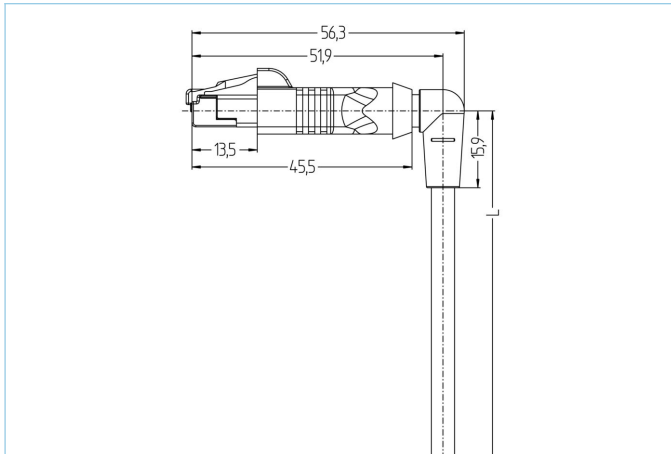

Product data

| | |
|--------------------|--------------------------|
| Item description | IE-W0RJ45SS8.005-2/S3400 |
| Item-No. | 8080677 |
| Length | 2m |
| Customs tariff-No. | 85444290 |
| Step-File | IE-W0RJ45SS8-m.stp |
| EAN | 4047106230029 |

Technical data

| | |
|--------------------------------|----------------------------------|
| Connector | male, angled, RJ45, 0° |
| Number of pins | 4 |
| Pin assignment | 1 WHOG, 2 OG, 3 WHBU, 6 BU |
| Rated voltage | 60V |
| Current load per pin (at 40°C) | 1A |
| Insulation resistance | ≥10 ⁹ Ω |
| Transmission features | Cat5e |
| Ambient temperature product | -40°C...+70°C |
| Contact material | Metal, CuSn, gold-plated |
| Contact-carrier material | Plastic, PA UL94-V0, transparent |
| Grip body material | Plastic, TPE, BK |
| Material of shielding housing | Metal, CuZn, nickel-plated |
| Shielding | with shielding |
| Standards | IEC 60603-7-5 |
| Degree of protection (mounted) | IP20 |
| Mechanical life-cycle | >750 mating cycles |
| Cable end assembly | open cable end |
| Degree of pollution | 1 |
| Style | angled |

Cable web Cat5e, PUR, UL, S3400

Shielded PUR Ethernet-cable for industrial applications. Fits to real-time requirements according to IEC61158. The cable meets the UL-Style 21815 (80°/300V)- and the Cat5 (electrical properties according to EN50288-2-2) requirements. Materials and a constructive setup for increased mechanical stresses (abrasion, bending, vibrations etc.) of the cable. Drag-chain/torsion operations are possible. High tensile strength through incorporated Kevlar-strands.

| | |
|------------------------------|-------------------------------------------------------------------------------------------------------------------------------------------------------------------------------------------------------------------------------|
| Outer diameter of jacket | 4.80 mm |
| Cable-jacket material | PUR |
| Jacket color | GN, similar RAL6018 |
| Wire cross-section | 1 x 4 x AWG26, star quad |
| Wire insulation material | PP |
| Wire colors | WHBU/BU, WHOG/OG |
| Wire structure | 19 x 0.10 mm |
| Bending radius (fixed) | 4 x Ø-cable |
| Bending radius (repeated) | 7,5 x Ø-cable |
| Temperature range (repeated) | -30°C...+70°C |
| Temperature range (fixed) | -40°C...+80°C |
| Transmission features | Cat5 |
| Rated voltage cable | 300 V UL rating |
| Special features | halogen free, high flexibility, hydrolysis proof, LABS free, microbes resistant, oil resistant, ozone resistant, recyclable, RoHs compliant, acid- and alkali resistant, drag chain-adapted, seawater resistant, UV resistant |

Classification

| | |
|------------|----------|
| eCl@ss 6.0 | 27061801 |
| eCl@ss 7.0 | 27060308 |
| eCl@ss 8.0 | 27060308 |
| eCl@ss 9.0 | 27060308 |
| ETIM 5.0 | EC002599 |
| ETIM 6.0 | EC002599 |

Link to product

<https://www.escha.net/en/products/standard/data-connectors/8080677>