

Y-splitter, M12, male, straight, 5 poles, with cable outlet, valve connector, housing style C, 2+PE, valve connector, housing style C, 2+PE, z-diode

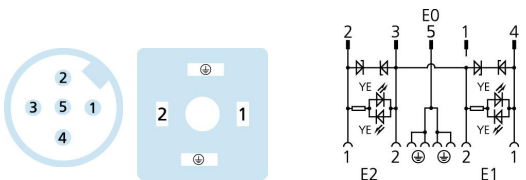
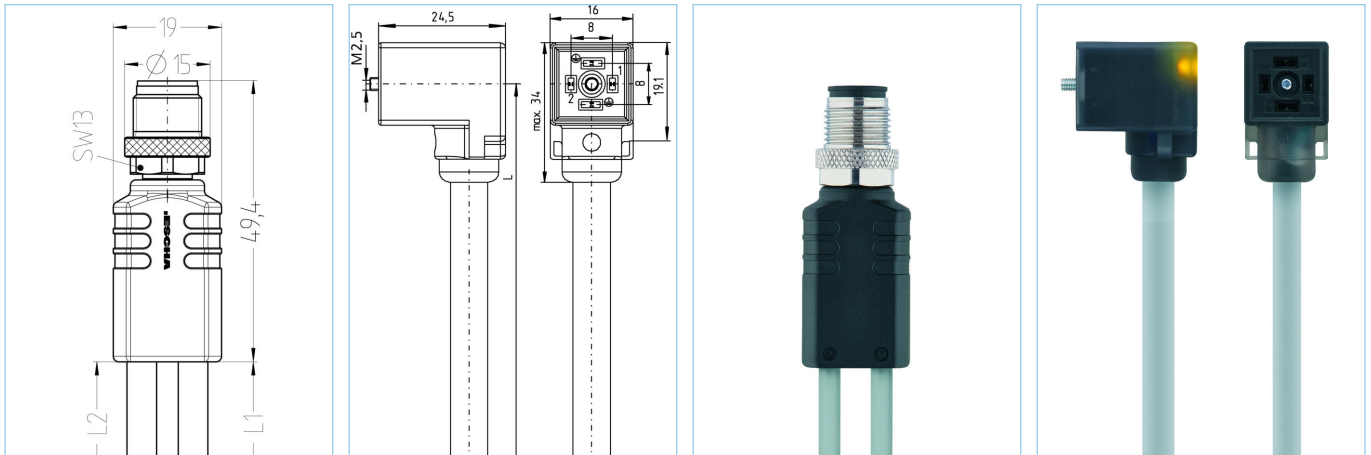

Product data

Item description	YK-FS5M12-2VC22-24.4-5/5/P00
Item-No.	8077649
Length	5m
Customs tariff-No.	85444290
Step-File	YK-FS5M12-2VC22-L_L.stp
EAN	4047106235451

Technical data	Exit 0	Exit 1	Exit 2
Connector	male, M12, straight	female, Valve C, angled	female, Valve C, female
Contact material	Metal, CuZn, gold-plated	Metal, CuSn, silver-plated	Metal, CuSn, silver-plated
Contact-carrier material	Plastic, TPU, BK	Plastic, PA, BK	Plastic, PA, BK
Coupling nut material	Metal, CuZn, nickel-plated		
Grip body material	Plastic, TPU, BK	Plastic, TPU, BK, translucent	Plastic, TPU, BK, translucent
Rated voltage	60V	24V _{AC/DC}	24V _{AC/DC}
Coding of	A		
Number of pins	5	2+PE, PE bridged	2+PE, PE bridged
Current load (at 40°C)	4A	4A	4A

Insulation resistance	≥10 ⁸ Ω
Ambient temperature product	-30°C...+90°C
Signal status-indicator	LED YE
Sealing (female) material	Plastic, TPU
Fixing screw	Metal, CuZn, nickel-plated
Mechanical life-cycle	>100 mating cycles
Standards	IEC 61076-2-101, DIN EN 175301-803
Degree of protection (mounted)	IP65, IP67, IP68
Protection circuit	Z-diode
Degree of pollution	3

Cable web PVC, P00, GY

PVC-cable for measurement and control-, and sensor technology. Suitable for applications in dry areas on packaging machines, assembly- and conveyor technology. High flexibility with unstressed movement (conditional drag-chain application possible). Predestined for applications in food- and beverage industry.

Outer diameter of jacket	4.90 mm
Cable-jacket material	PVC
Jacket color	GY, similar RAL7040
Wire cross-section	4+1 x 0.34mm ²
Wire insulation material	PVC
Wire colors	BN, WH, BU, BK, GNYE
Wire structure	19 x 0.15 mm
Bending radius (fixed)	5 x Ø-cable
Bending radius (repeated)	10 x Ø-cable
Temperature range (repeated)	0°C...+80°C
Temperature range (fixed)	-25°C...+80°C
Rated voltage cable	≤300 V
Special features	good resistance against oils and chemicals, LABS free, ozone resistant, recyclable, RoHs compliant, acid- and alkali resistant, seawater resistant, UV resistant

Classification

eCl@ss 6.0	27279218
eCl@ss 7.0	27279218
eCl@ss 8.0	27279218
eCl@ss 9.0	27060313
ETIM 5.0	EC001855
ETIM 6.0	EC001855

Link to product

<https://www.escha.net/en/products/standard/t-splitters-y-splitters/8077649>