

Receptacle, M12, female, straight, 12 poles, back wall-mounting, print contact

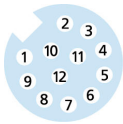
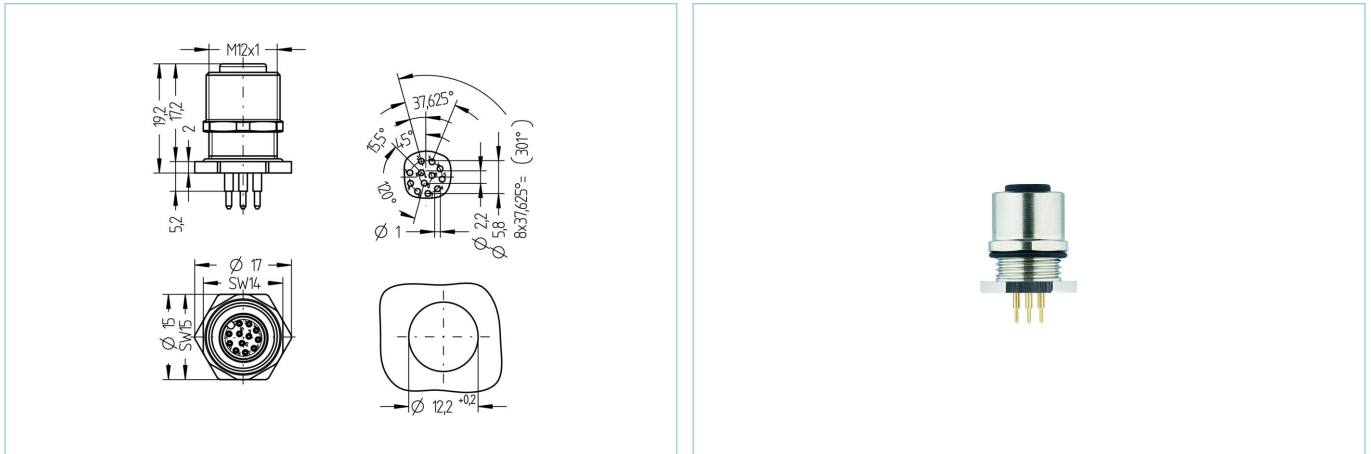

Product data	
Item description	AL-FHM12KUA12-P/M12/S3540
Item-No.	8076571
Customs tariff-No.	85366990
Packaging unit	10
Step-File	AL-FHM12KUA12-P_M12_S3540.stp
EAN	4047106252625
Technical data	
Connector	female, straight, M12
Number of pins	12
Coding	A
Rated voltage	30V
Current load per pin (at 40°C)	1.5A
Insulation resistance	≥10 ⁹ Ω
Ambient temperature product	-30°C...+90°C
Reflow	2 min. 250 °C
Contact material	Metal, CuZn, gold-plated
Contact-carrier material	Plastic, PA GF, BK
Receptacle housing material	Metal, CuZn, nickel-plated
Sealing (female) material	FPM/FKM
Material of external sealing	NBR
Mounting direction	Back wall-mounting (incl. Fixing screw)
Wrench size of fastening nut	A/F14
Wall thickness area (Δh)	2,5...4,0 mm
Fastening thread	M12x1
Connecting type	Print contact
Standards	IEC 61076-2-101
Degree of protection (mounted)	IP65, IP67, IP68
Mechanical life-cycle	>100 mating cycles
Degree of pollution	3
Style	straight

Classification

eCl@ss 6.0	27279220
eCl@ss 7.0	27440103
eCl@ss 8.0	27440103
eCl@ss 9.0	27440103
ETIM 5.0	EC002061
ETIM 6.0	EC002061

Link to product

<https://www.escha.net/en/products/standard/receptacles/8076571>