

Y-splitter, M8, female, straight, 4 poles, with open cable end

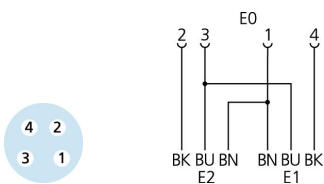
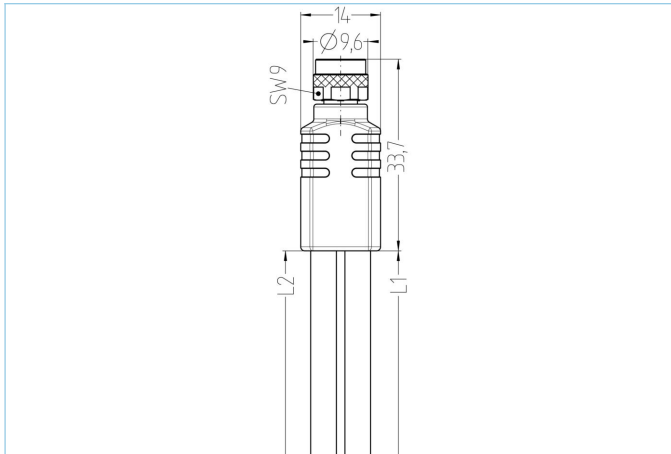

Product data

Item description	YK-FK4M8-10/10/S370
Item-No.	8075665
Length	10m
Customs tariff-No.	85444290
Step-File	YK-FK4M8-L_L.stp
EAN	4047106175580

Technical data	Exit 0	Exit 1	Exit 2
Connector	female, M8, straight	open cable end	open cable end
Contact material	Metal, CuZn, gold-plated		
Contact-carrier material	Plastic, TPU, BK		
Coupling nut material	Metal, CuZn, nickel-plated		
Rated voltage	60V		
Coding of	A		
Number of pins	4		
Current load (at 40°C)	4A		

Pin assignment	1 BN, 2 BK, 3 BU, 4 BK
Insulation resistance	$\geq 10^8 \Omega$
Resistance	$\leq 5m\Omega$
Ambient temperature product	-30°C...+90°C
Grip body material	Plastic, TPU, BK
Sealing (female) material	FPM/FKM
Mechanical life-cycle	>100 mating cycles
Standards	IEC 61076-2-104
Degree of protection (mounted)	IP65, IP67, IP68
Cable end assembly	open cable end
Degree of pollution	3

Cable web	PUR, UL, S370
------------------	----------------------

Flexible, silicone- and halogen-free control line with high mechanical strength. The cable is chemicals, hydrolysis-, and microbes- resistant. The drag-chain application is possible at a bending radius of minimum 10 x d. Due to its weld-field immunity, the cable is very well suited for the flexible application in robotics, machine-tool, and metal-cutting production. The cables meet the UL and CSA (UL10493/20549; cULus) requirements.

Outer diameter of jacket	4.00 mm
Cable-jacket material	PUR
Jacket color	BK, similar RAL9005
Wire cross-section	3 x 0.25 mm ²
Wire insulation material	PP
Wire colors	BN, BU, BK
Wire structure	32 x 0.10 mm
Bending radius (fixed)	5 x Ø-cable
Bending radius (repeated)	10 x Ø-cable
Temperature range (repeated)	-30°C...+90°C
Temperature range (fixed)	-40°C...+90°C
Temperature range (drag chain)	-25°C...+60°C
Drag chain-application	5 Mio. cycles
Halogen-free	Yes
Torsion	+/-360°/m, ≥ 2 Mio. cycles
Rated voltage cable	≤300 V
Special features	flame retardant, halogen free, hydrolysis proof, LABS free, oil resistant, ozone resistant, recyclable, RoHs compliant, acid- and alkali resistant, drag chain-adapted, welding sparks resistant, seawater resistant, silicone free, torsion resistant, UV resistant

Classification	
-----------------------	--

eCl@ss 6.0	27279218
eCl@ss 7.0	27279218
eCl@ss 8.0	27279218
eCl@ss 9.0	27060313
ETIM 5.0	EC001855
ETIM 6.0	EC001855

Link to product	
------------------------	--

<https://www.escha.net/en/products/standard/t-splitters-y-splitters/8075665>