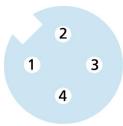
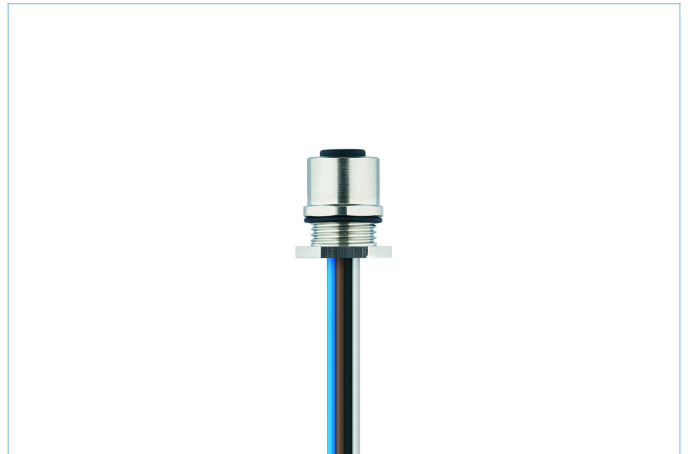
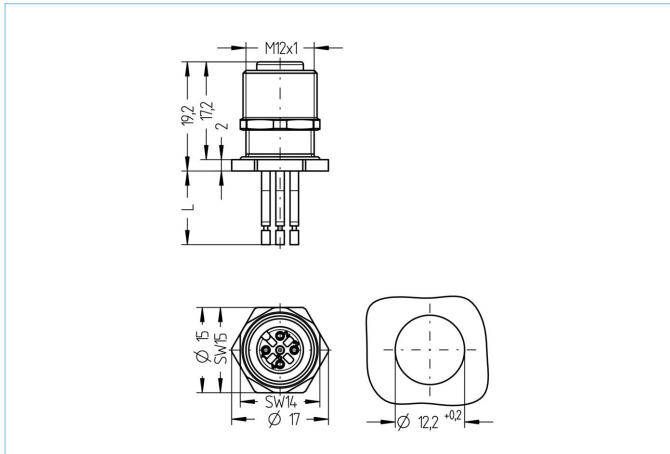

Receptacle, M12, female, straight, 4 poles, back wall-mounting, wire contact, rail approved

Product data

Item description	RA-FHM12KUA4-0,5/M12/S3525
Item-No.	8074756
Customs tariff-No.	85444290
Step-File	RA-FHM12KUA4-L_M12_S3525.stp
EAN	4047106161910

Technical data

Connector	female, straight, M12
Number of pins	4
Pin assignment	1 BN, 2 WH, 3 BU, 4 BK
Coding	A
Rated voltage	250V
Current load per pin (at 40°C)	4A
Insulation resistance	≥10 ⁹ Ω
Ambient temperature product	-40°C...+90°C
Contact material	Metal, CuZn, gold-plated
Contact-carrier material	Plastic, PA GF, BK
Receptacle housing material	Metal, CuZn, nickel-plated
Sealing (female) material	FPM/FKM
Material of external sealing	FPM/FKM
Mounting direction	Back wall-mounting (incl. Fixing screw)
Wrench size of fastening nut	A/F14
Wall thickness area (Δh)	1,0...2,5 mm
Wire length	0.50m
Wire colors	BN, WH, BU, BK
Wire cross-section	4 x 0.5 mm ²
Wire insulation material	FRNC (EN45545-2)
Fastening thread	M12x1

Connecting type	Wire contact
Standards	IEC 61076-2-101
Degree of protection (mounted)	IP65, IP67, IP68
Mechanical life-cycle	>100 mating cycles
Degree of pollution	3
Style	straight

Advanced technical data rail approved

Standards	DIN EN 50155, DIN EN 45545-2
Shock & vibration	Class 1, Category B (DIN EN 61373)
Degree of protection (mounted)	IP67 (-30°C...+90°C), IP65 (-40°C...+90°C)
Temperature range	Tx (-40°C...+90°C)
Fire prevention according to	DIN EN 45545-2 HL1-3

Classification

eCl@ss 6.0	27279220
eCl@ss 7.0	27440103
eCl@ss 8.0	27440103
eCl@ss 9.0	27440103
ETIM 5.0	EC002061
ETIM 6.0	EC002061

Link to product

<https://www.escha.net/en/products/standard/connectors-for-the-rail-industry/8074756/receptacle-m12-female-straight-rail-approved-4-poles-a-coded-back-wall-mounting-wire-contact>