

I/O-junctions passive, 8 ports, fixed cable connection, M12, female, 4+PE

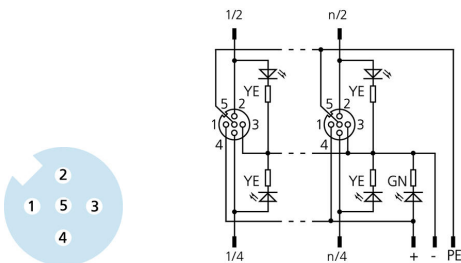
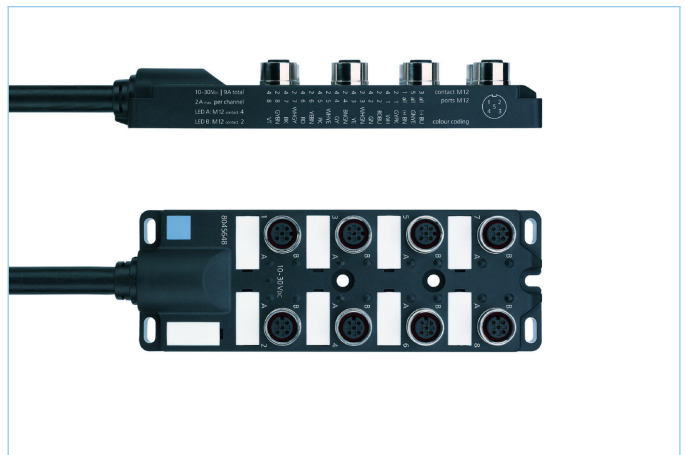
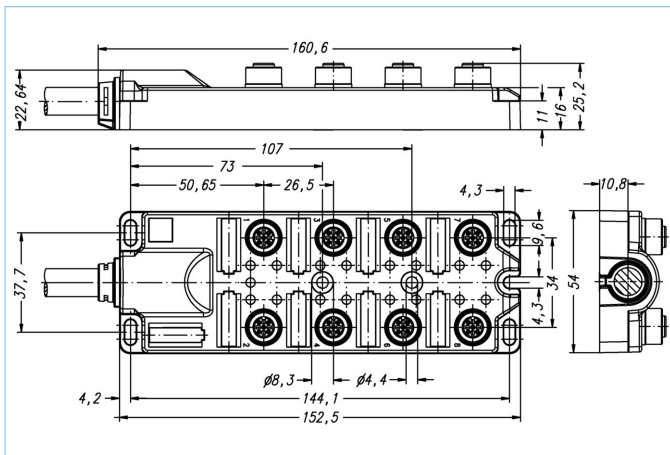

Product data

Item description	8/OM12-5P3C-1/S370
Item-No.	8070539
Length	1m
Customs tariff-No.	85444290
Step-File	8IOM12-5P3C.stp
EAN	4047106258443
Remark	Labels (white) not included

Technical data

I/O-junction	8-way, with cable
I/O-slot	female, M12
Number of pins	4+PE
Rated voltage	30V
Current load per pin (at 40°C)	2A
Total current load	12A
Insulation resistance	$\geq 10^9 \Omega$
Resistance	$\leq 5 m\Omega$
Ambient temperature product	-30°C...+90°C
Number of LEDs	17
Number of I/O-slots	8
Circuit logic	pnp
Signal status-indicator	LED YE
Operating voltage-indicator	LED GN
Contact material	Metal, CuZn, gold-plated
Contact-carrier material	Plastic, PA, BK
Sealing (female) material	FPM/FKM
Housing material	Plastic, PA, BK

Thread insert material	Metal, CuZn
Connecting type	Fixed cable connection
Standards	IEC 61076-2-101
Degree of protection (mounted)	IP65, IP67
Mechanical life-cycle	>100 mating cycles
Degree of pollution	3

Cable web	PUR, UL, S370
------------------	----------------------

Flexible, silicone- and halogen-free control line with high mechanical strength. The cable is chemicals, hydrolysis-, and microbes- resistant. The drag-chain application is possible at a bending radius of minimum 10 x d. Due to its weld-field immunity, the cable is very well suited for the flexible application in robotics, machine-tool, and metal-cutting production. The cables meet the UL and CSA (UL10493/20549; cULus) requirements.

Outer diameter of jacket	9.7 mm
Cable-jacket material	PUR
Jacket color	BK, similar RAL9005
Wire cross-section	16 x 0.34 mm ² + 3 x 1 mm ²
Wire insulation material	PP
Wire colors	VT, RD, GY, GN, BK, WH, PK, YE, RDBU, GYPK, WHGN, WHYE, WHGY, YEBN, BNGN, GYBN, BN, BU, GNYE
Bending radius (repeated)	min. 10 x Ø-cable
Temperature range (repeated)	-5°C...+80°C
Temperature range (fixed)	-40°C...+80°C
Drag chain-application	2 Mio. cycles
Halogen-free	Yes
Special features	flame retardant, halogen free, LABS free, RoHs compliant, drag chain-adapted

Allocation chart

I/O	1		2		3		4		5		6		7		8		all (+)	all (-)	all (FE)
Pin	2	4	2	4	2	4	2	4	2	4	2	4	2	4	2	4	1	3	5
Cable	GYPK	WH	RDBU	GN	WHGN	YE	BNGN	GY	WHYE	PK	YEBN	RD	WHGY	BK	GYBN	VT	BN	BU	GNYE

Classification

eCl@ss 6.0	27279219
eCl@ss 7.0	27279219
eCl@ss 8.0	27279219
eCl@ss 9.0	27440108
ETIM 5.0	EC002585
ETIM 6.0	EC002585

Accessories

Screw plug, M12 https://www.escha.net/en/products/standard/accessories-for-connectivity/8081767
Labels, I/O-junction passive, I/O-junction active https://www.escha.net/en/products/standard/accessories-for-connectivity/8015002
Accessories set, I/O-junction passive, M12 https://www.escha.net/en/products/standard/accessories-for-connectivity/8087215