

M8, female, straight, 3 poles, M8, male, straight, 3 poles, Food & Beverage

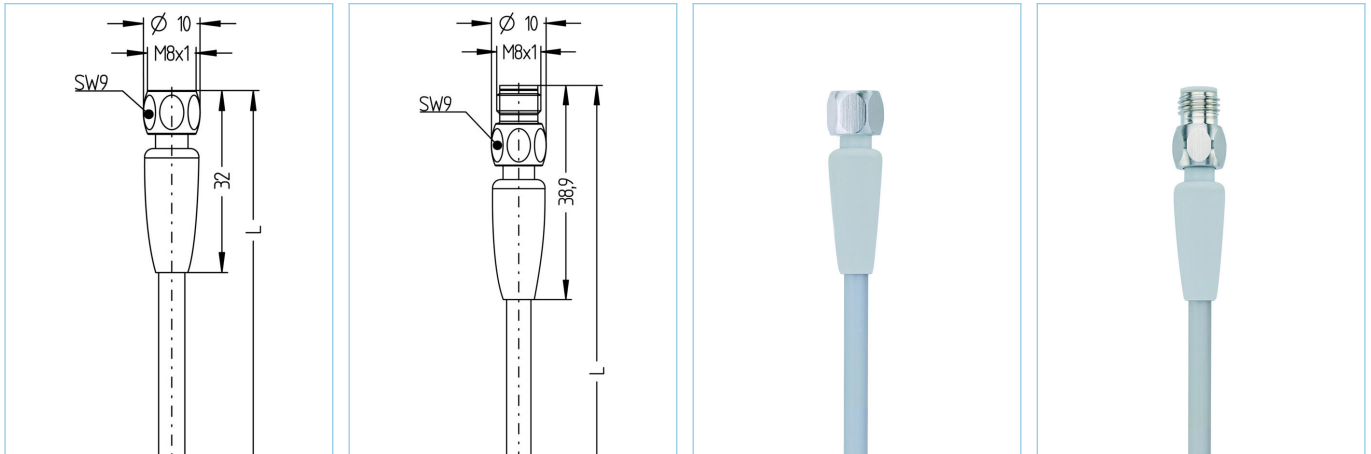

Product data

Item description	FB-SKPH3-5-FB-SSPH3/P00
Item-No.	8063877
Length	5m
Customs tariff-No.	85444290
Step-File	FB-SKPH3-L-FB-SSPH3.stp
EAN	4047106151843

Technical data

	A-side	B-side
Connector	female, straight, M8	male, straight, M8
Number of pins	3	3
Pin assignment	1 BN, 3 BU, 4 BK	1 BN, 3 BU, 4 BK
Rated voltage	60V	60V
Current load (at 40°C)	4A	4A
Insulation resistance	$\geq 10^9 \Omega$	$\geq 10^9 \Omega$
Ambient temperature product	-40°C...+105°C	-40°C...+105°C
Contact material	Metal, CuZn, gold-plated	Metal, CuZn, gold-plated
Contact-carrier material	Plastic, PP, GY	Plastic, PP, GY
Grip body material	Plastic, TPE, GY	Plastic, TPE, GY
Coupling nut material	Stainless steel, V4A	Stainless steel, V4A
Sealing (female) material	EPDM	
Standards	IEC 61076-2-104	IEC 61076-2-104
Degree of protection (mounted)	IP65, IP67, IP68, IP69	IP65, IP67, IP68, IP69
Mechanical life-cycle	>100 mating cycles	>100 mating cycles
Degree of pollution	3	3

Cable web PVC, P00, GY

PVC-cable for measurement and control-, and sensor technology. Suitable for applications in dry areas on packaging machines, assembly- and conveyor technology. High flexibility with unstressed movement (conditional drag-chain application possible). Predestined for applications in food- and beverage industry.

Outer diameter of jacket	4.00 mm
Cable-jacket material	PVC
Jacket color	GY, similar RAL7040
Wire cross-section	3 x 0.25 mm ²
Wire insulation material	PVC
Wire colors	BN, BU, BK
Wire structure	14 x 0.15 mm
Bending radius (fixed)	5 x Ø-cable
Bending radius (repeated)	10 x Ø-cable
Temperature range (repeated)	0°C...+80°C
Temperature range (fixed)	-25°C...+80°C
Rated voltage cable	≤300 V
Special features	good resistance against oils and chemicals, LABS free, ozone resistant, recyclable, RoHs compliant, acid- and alkali resistant, seawater resistant, UV resistant

Classification

eCl@ss 6.0	27279218
eCl@ss 7.0	27279218
eCl@ss 8.0	27279218
eCl@ss 9.0	27060311
ETIM 5.0	EC001855
ETIM 6.0	EC001855

Accessories

Mounting-set, M8

<https://www.escha.net/en/products/standard/accessories-for-connectivity/8047663>

Torque-wrench set

<https://www.escha.net/en/products/standard/accessories-for-connectivity/8055431>

Marking rings Ø 9mm

<https://www.escha.net/en/products/standard/accessories-for-connectivity?p=1&o=3&n=15&f=809>

Link to product

<https://www.escha.net/en/products/standard/connectors-for-the-food-industry/8063877>