

M12, female, straight, 5 poles, M12, male, straight, 5 poles, Food & Beverage

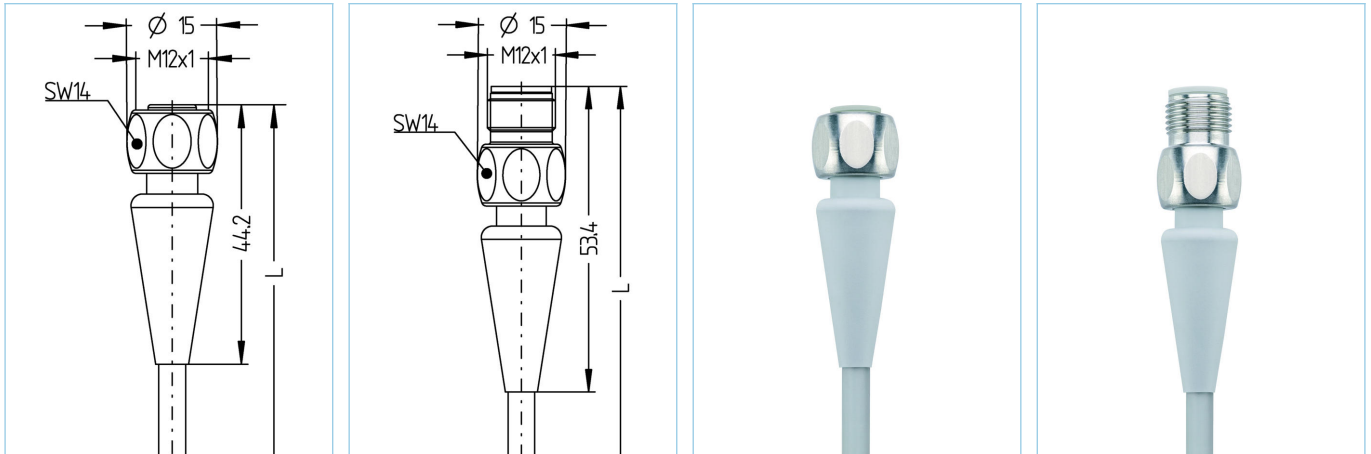

| Product data       |                             |
|--------------------|-----------------------------|
| Item description   | FB-WAKH4.5-5-FB-WASH4.5/P00 |
| Item-No.           | 8063851                     |
| Length             | 5m                          |
| Customs tariff-No. | 85444290                    |
| Step-File          | FB-WAKH4.5-L-FB-WASH4.5.stp |
| EAN                | 4047106151607               |

| Technical data                 | A-side                       | B-side                       |
|--------------------------------|------------------------------|------------------------------|
| Connector                      | female, straight, M12        | male, straight, M12          |
| Number of pins                 | 5                            | 5                            |
| Pin assignment                 | 1 BN, 2 WH, 3 BU, 4 BK, 5 GY | 1 BN, 2 WH, 3 BU, 4 BK, 5 GY |
| Coding of                      | A                            | A                            |
| Rated voltage                  | 60V                          | 60V                          |
| Current load (at 40°C)         | 4A                           | 4A                           |
| Insulation resistance          | ≥10 <sup>8</sup> Ω           | ≥10 <sup>8</sup> Ω           |
| Resistance                     | ≤ 5mΩ                        | ≤ 5mΩ                        |
| Ambient temperature product    | -40°C...+105°C               | -40°C...+105°C               |
| Contact material               | Metal, CuZn, gold-plated     | Metal, CuZn, gold-plated     |
| Contact-carrier material       | Plastic, PP, GY              | Plastic, PP, GY              |
| Grip body material             | Plastic, TPE, GY             | Plastic, TPE, GY             |
| Coupling nut material          | Stainless steel, V4A         | Stainless steel, V4A         |
| Sealing (female) material      | EPDM                         |                              |
| Standards                      | IEC 61076-2-101              | IEC 61076-2-101              |
| Degree of protection (mounted) | IP65, IP67, IP68, IP69       | IP65, IP67, IP68, IP69       |
| Mechanical life-cycle          | >100 mating cycles           | >100 mating cycles           |
| Degree of pollution            | 3                            | 3                            |

**Cable web** PVC, P00, GY

PVC-cable for measurement and control-, and sensor technology. Suitable for applications in dry areas on packaging machines, assembly- and conveyor technology. High flexibility with unstressed movement (conditional drag-chain application possible). Predestined for applications in food- and beverage industry.

|                              |  |
|------------------------------|--|
| Outer diameter of jacket     | 4.90 mm  |
| Cable-jacket material        | PVC  |
| Jacket color                 | GY, similar RAL7040  |
| Wire cross-section           | 5 x 0.34 mm <sup>2</sup>   |
| Wire insulation material     | PVC  |
| Wire colors                  | BN, WH, BU, BK, GY   |
| Wire structure               | 19 x 0.15 mm   |
| Bending radius (fixed)       | 5 x Ø-cable  |
| Bending radius (repeated)    | 10 x Ø-cable   |
| Temperature range (repeated) | 0°C...+80°C  |
| Temperature range (fixed)    | -25°C...+80°C  |
| Rated voltage cable          | ≤300 V   |
| Special features             | good resistance against oils and chemicals, LABS free, ozone resistant, recyclable, RoHs compliant, acid- and alkali resistant, seawater resistant, UV resistant |

**Classification**

|            |          |
|------------|----------|
| eCl@ss 6.0 | 27279218 |
| eCl@ss 7.0 | 27279218 |
| eCl@ss 8.0 | 27279218 |
| eCl@ss 9.0 | 27060311 |
| ETIM 5.0   | EC001855 |
| ETIM 6.0   | EC001855 |

**Accessories**
**Mounting-set, M12**

<https://www.escha.net/en/products/standard/accessories-for-connectivity/8047664>

**Torque-wrench set**

<https://www.escha.net/en/products/standard/accessories-for-connectivity/8055431>

**Marking rings Ø 9mm**

<https://www.escha.net/en/products/standard/accessories-for-connectivity?p=1&o=3&n=15&f=809>

**Food & Beverage, Adapter**

<https://www.escha.net/en/products/standard/accessories-for-connectivity/8063392>

**Link to product**

<https://www.escha.net/en/products/standard/connectors-for-the-food-industry/8063851>