

Receptacle Single-ended cordset, M12, female, angled, 5 poles, B-coded, back wall-mounting, shielded, Profi-bus

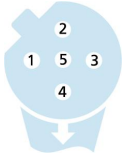
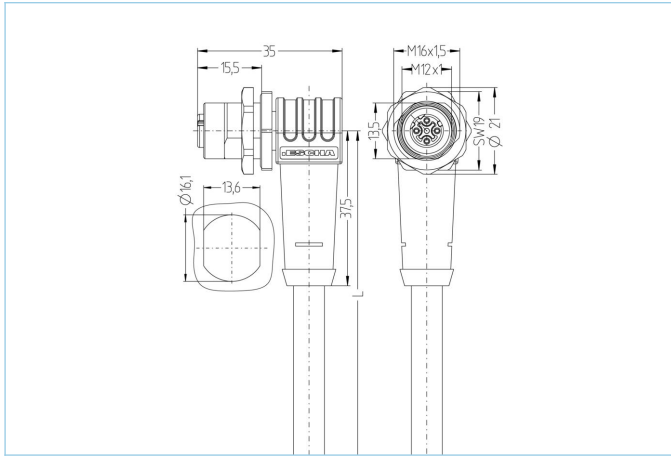

Product data	
Item description	PB-WFKFDSW2.012-5/16/S1800
Item-No.	8063619
Length	5m
Customs tariff-No.	85444290
Step-File	PB-WFKFDSW2_012-m_16.stp
EAN	4047106149598
Technical data	
Connector	female, angled, M12
Number of pins	5
Pin assignment	1 n.c., 2 GN, 3 n.c., 4 RD, 5 n.c.
Coding	B
Rated voltage	60V
Current load per pin (at 40°C)	4A
Insulation resistance	≥10 ⁹ Ω
Ambient temperature product	-30°C...+90°C
Contact material	Metal, CuZn, gold-plated
Contact-carrier material	Plastic, TPU, VT
Grip body material	Plastic, TPU, BK
Receptacle housing material	Metal, CuZn, nickel-plated
Sealing (female) material	FPM/FKM
Material of external sealing	NBR
Shielding	with shielding
Mounting direction	Back wall-mounting (incl. Fixing screw)
Adjustable fixing screw	Yes
Fastening thread	M16x1.5

Connecting type	Cable
Standards	IEC 61076-2-101
Degree of protection (mounted)	IP65, IP67, IP68
Mechanical life-cycle	>100 mating cycles
Degree of pollution	3
Style	angled

Advanced technical data rail approved

Standards	DIN EN 50155, DIN EN 45545-2
Shock & vibration	Class 1, Category B (DIN EN 61373)
Degree of protection (mounted)	IP67 (-30°C...+90°C), IP65 (-40°C...+90°C)
Temperature range	Tx (-40°C...+90°C)
Fire prevention according to	DIN EN 45545-2 HL1-3

Cable web PUR, UL, S1800, Profibus

UL- and CSA-listed shielded PUR-cable for automation technology (control of sensors and actuators). Suited for common variants of PROFIBUS DP and PROFIBUS PA. Setup and materials used allow for applications under harsh environment conditions (abrasion, bending, vibrations etc.). Drag-chain application is possible. (>1million bending cycles).

Outer diameter of jacket	7.60 mm
Cable-jacket material	PUR
Jacket color	VT similar RAL4001
Wire cross-section	1 x 2 x 0.34 mm ²
Wire insulation material	PE
Wire colors	RD, GN
Wire structure	19 x 0.15 mm
Bending radius (fixed)	5 x Ø-cable
Bending radius (repeated)	15 x Ø-cable
Temperature range (repeated)	-25°C...+80°C
Temperature range (fixed)	-50°C...+80°C
Temperature range (drag chain)	-25°C...+60°C
Drag chain-application	>1Mio. cycles
Shielding	Yes
Halogen-free	Yes
Rated voltage cable	300 V
Special features	flame retardant, halogen free, high flexibility, hydrolysis proof, LABS free, microbes resistant, oil resistant, ozone resistant, recyclable, RoHs compliant, acid- and alkali resistant, drag chain-adapted, seawater resistant, UV resistant

Classification

eCl@ss 6.0	27279220
eCl@ss 7.0	27440103
eCl@ss 8.0	27440103
eCl@ss 9.0	27440103
ETIM 5.0	EC002061
ETIM 6.0	EC002061

Link to product

<https://www.escha.net/en/products/standard/receptacles/8063619>