

Receptacle Single-ended cordset, M12, female, straight, 4 poles, D-coded, front wall-mounting, shielded, Industrial Ethernet

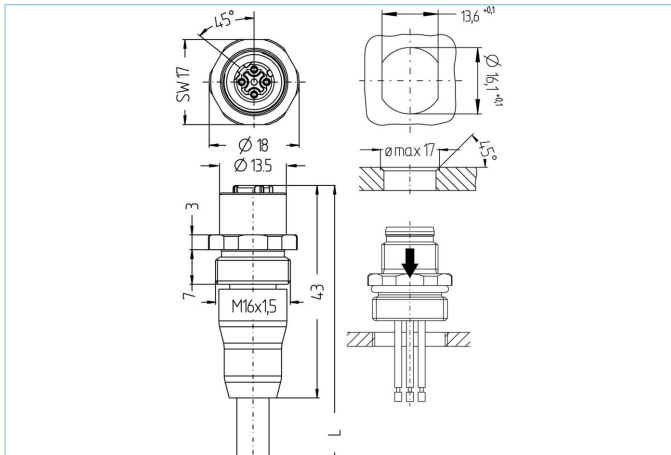

Product data

Item description	IE-FKSY4.029-5/16/S2171/S3941
Item-No.	8063615
Length	5m
Customs tariff-No.	85444290
Step-File	IE-FKSY4_029-m_16.stp
EAN	4047106149550

Technical data

Connector	female, straight, M12
Number of pins	4
Pin assignment	1 YE, 2 WH, 3 OG, 4 BU
Coding	D
Rated voltage	60V
Current load per pin (at 40°C)	4A
Insulation resistance	≥10 ⁹ Ω
Transmission features	Cat5e
Ambient temperature product	-30°C...+70°C
Contact material	Metal, CuZn, gold-plated
Contact-carrier material	Plastic, PA, GN
Grip body material	Plastic, hot melt, transparent
Receptacle housing material	Metal, CuZn, nickel-plated
Sealing (female) material	FPM/FKM
Material of external sealing	NBR
Shielding	with shielding
Mounting direction	Front wall-mounting (without fixing screw)
Adjustable fixing screw	No
Fastening thread	M16x1.5

Connecting type	Cable
Standards	IEC 61076-2-101
Degree of protection (mounted)	IP65, IP67, IP68
Mechanical life-cycle	>100 mating cycles
Degree of pollution	3
Style	straight

Cable web	Cat5e, PUR, UL, S2171, PROFINET
------------------	--

Shielded, PUR-cable for industrial applications. The cable is CMX-verified or meets the Cat5e (electrical properties of EN 50288-2-1) requirements. Materials and a constructive setup allow for increased mechanical stresses (abrasion, bending, vibrations etc.) of the cable. A drag-chain application with up to 3 million bending cycles is possible.

Outer diameter of jacket	6.50 mm
Cable-jacket material	PUR
Jacket color	GN, similar RAL6018
Wire cross-section	1 x 4 x AWG22, star quad
Wire insulation material	FRNC
Wire colors	WH, BU, OG, YE
Wire structure	7 x 0.25 mm
Bending radius (fixed)	4 x Ø-cable
Bending radius (repeated)	8 x Ø-cable
Temperature range (repeated)	-30°C...+70°C
Temperature range (fixed)	-40°C...+75°C
Drag chain-application	3 Mio. bending cycles
Halogen-free	Yes
Transmission features	Cat5e
Rated voltage cable	600 V UL rating
Special features	flame retardant, halogen free, high flexibility, hydrolysis proof, LABS free, microbes resistant, oil resistant, ozone resistant, PROFINET Type C, recyclable, RoHs compliant, acid- and alkali resistant, drag chain-adapted, seawater resistant, UN ECE R 118, UV resistant

Classification	
-----------------------	--

eCl@ss 6.0	27279220
eCl@ss 7.0	27440103
eCl@ss 8.0	27440103
eCl@ss 9.0	27440103
ETIM 5.0	EC002061
ETIM 6.0	EC002061

Link to product

<https://www.escha.net/en/products/standard/data-connectors/8063615>