

Double-valve connector, housing style A, 2+PE bridged, suppressor diode, sensor-/actuator cable

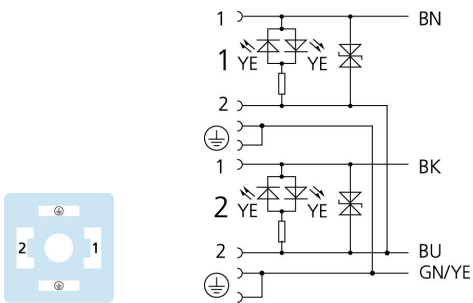
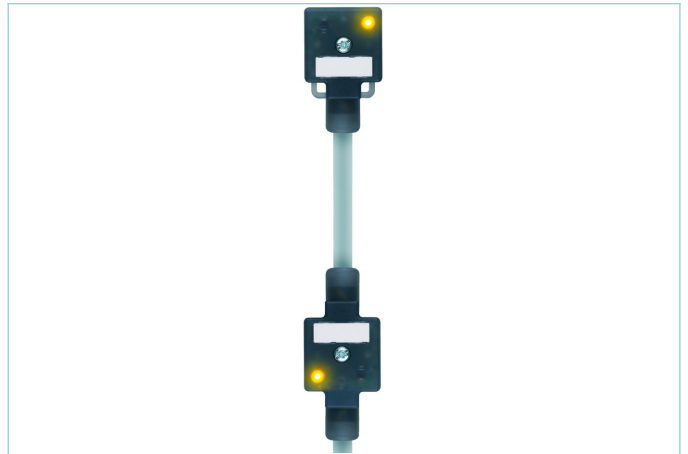
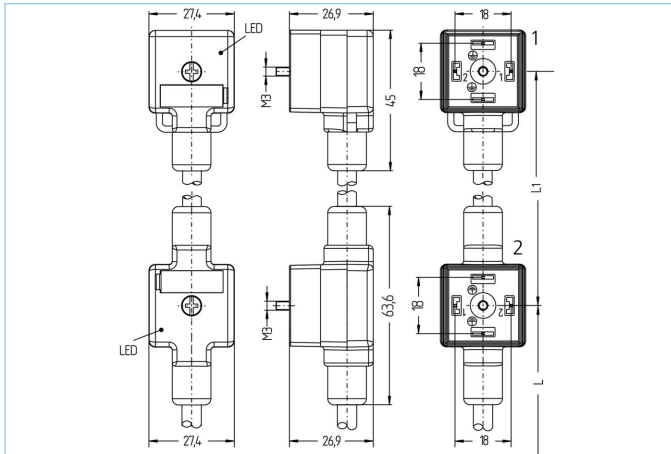

Product data

Item description	VA22-24.3-0,4-DA22-24.3-2/P00
Item-No.	8055752
Length	2m
Distance of valve connectors	0.40m
Customs tariff-No.	85444290
Step-File	VA22-24_3-L-DA22-24_3-m_S_.stp
EAN	4047106140793

Technical data	Exit 0	Exit 1	Exit 2
Connector	female, angled, Ventil A	female, angled, Ventil D	open cable end
Contact material	Metal, CuZn, silver-plated	Metal, CuZn, silver-plated	
Contact-carrier material	Plastic, PA, BK	Plastic, PA, BK	
Rated voltage	30V _{AC/DC}	30V _{AC/DC}	
Number of pins	2+PE, PE bridged	2+PE, PE bridged	
Current load (at 40°C)	4A	4A	
Pin-Belegung	1 BN, 2 BU, 3 n.c., PE: GNYE	1 BK, 2 BU, 3 n.c., PE: GNYE	
Befestigungsschraube	Metall, CuZn, vernickelt	Metall, CuZn, vernickelt	
Signal status-indicator	LED YE/YE	LED YE/YE	
Protection circuit	Suppressor diode	Suppressor diode	
Insulation resistance	≥10 ⁹ Ω		
Ambient temperature product	-30°C...+90°C		
Grip body material	Plastic, TPU, BK, translucent		
Sealing (female) material	Plastic, TPU		
Mechanical life-cycle	>100 mating cycles		
Degree of protection (mounted)	IP65, IP67, IP68		
Degree of pollution	3		

Cable web PVC, P00, GY

PVC-cable for measurement and control-, and sensor technology. Suitable for applications in dry areas on packaging machines, assembly- and conveyor technology. High flexibility with unstressed movement (conditional drag-chain application possible). Predestined for applications in food- and beverage industry.

Outer diameter of jacket	7.3 mm
Cable-jacket material	PVC
Jacket color	GY, similar RAL7040
Wire cross-section	4 x 0.75 mm ²
Wire insulation material	PVC
Wire colors	BN, BK, BU, GNYE
Wire structure	24 x 0,20 mm
Bending radius (fixed)	5xØ-cable
Bending radius (repeated)	10 x Ø-cable
Temperature range (repeated)	0°C...+80°C
Temperature range (fixed)	-25°C...+80°C
Rated voltage cable	240 V
Special features	good resistance against oils and chemicals, LABS free, ozone resistant, recyclable, RoHs compliant, acid- and alkali resistant, seawater resistant, UV resistant

Classification

eCl@ss 6.0	27279218
eCl@ss 7.0	27279218
eCl@ss 8.0	27279218
eCl@ss 9.0	27060312
ETIM 5.0	EC001855
ETIM 6.0	EC001855

Accessories

Labels, Valve connector
<https://www.escha.net/en/products/standard/accessories-for-connectivity/8047109>

Fixing screw
<https://www.escha.net/en/products/standard/accessories-for-connectivity/8060907>

Link to product

<https://www.escha.net/en/products/standard/valve-connectors/8055752>