

Double-valve connector, housing style A, 2+PE bridged, suppressor diode, sensor-/actuator cable

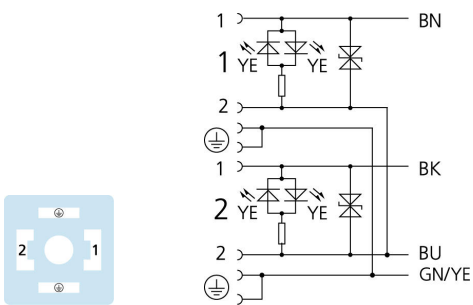
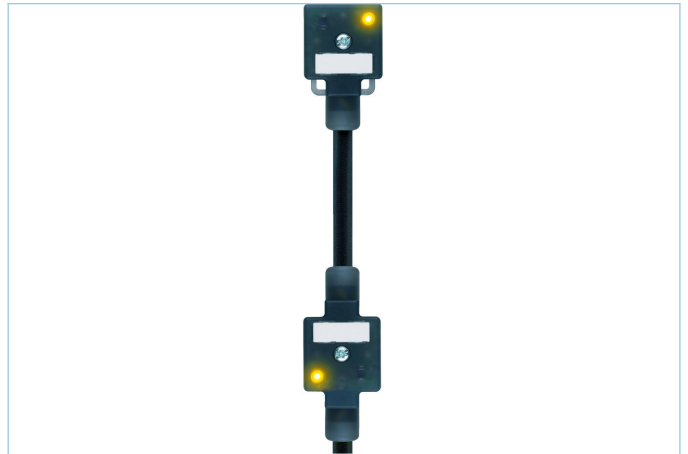
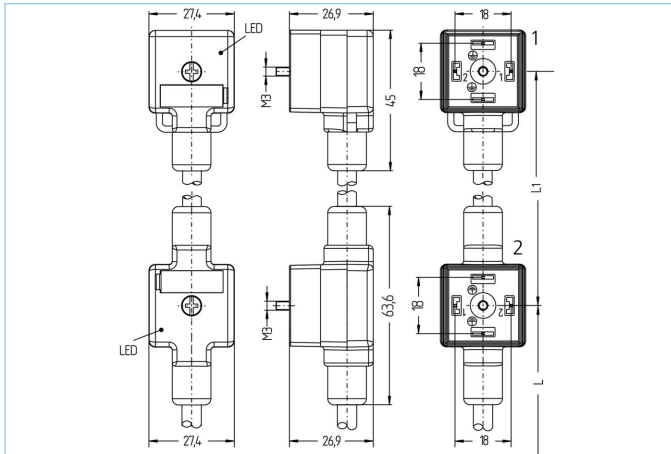

Product data

Item description	VA22-24.3-0,4-DA22-24.3-5/S370
Item-No.	8055747
Length	5m
Distance of valve connectors	0.40m
Customs tariff-No.	85444290
Step-File	VA22-24_3-L-DA22-24_3-m_S_.stp
EAN	4047106140748

Technical data	Exit 0	Exit 1	Exit 2
Connector	female, angled, Ventil A	female, angled, Ventil D	open cable end
Contact material	Metal, CuZn, silver-plated	Metal, CuZn, silver-plated	
Contact-carrier material	Plastic, PA, BK	Plastic, PA, BK	
Rated voltage	30V _{AC/DC}	30V _{AC/DC}	
Number of pins	2+PE, PE bridged	2+PE, PE bridged	
Current load (at 40°C)	4A	4A	
Pin-Belegung	1 BN, 2 BU, 3 n.c., PE: GNYE	1 BK, 2 BU, 3 n.c., PE: GNYE	
Befestigungsschraube	Metall, CuZn, vernickelt	Metall, CuZn, vernickelt	
Signal status-indicator	LED YE/YE	LED YE/YE	
Protection circuit	Suppressor diode	Suppressor diode	
Insulation resistance	≥10 ⁹ Ω		
Ambient temperature product	-30°C...+90°C		
Grip body material	Plastic, TPU, BK, translucent		
Sealing (female) material	Plastic, TPU		
Mechanical life-cycle	>100 mating cycles		
Degree of protection (mounted)	IP65, IP67, IP68		
Degree of pollution	3		

Cable web	PUR, UL, S370
------------------	----------------------

Flexible, silicone- and halogen-free control line with high mechanical strength. The cable is chemicals, hydrolysis-, and microbes- resistant. The drag-chain application is possible at a bending radius of minimum 10 x d. Due to its weld-field immunity, the cable is very well suited for the flexible application in robotics, machine-tool, and metal-cutting production. The cables meet the UL and CSA (UL10493/20549; cULus) requirements.

Outer diameter of jacket	6.4 +/- 0.2 mm
Cable-jacket material	PUR
Jacket color	BK, similar RAL9005
Wire cross-section	4 x 0.75 mm ²
Wire insulation material	PP
Wire colors	BN, BK, BU, GNYE
Wire structure	42 x 0,15 mm
Bending radius (fixed)	5 x Ø-cable
Bending radius (repeated)	10 x Ø-cable
Temperature range (repeated)	-30°C...+90°C
Temperature range (fixed)	-40°C...+90°C
Temperature range (drag chain)	-25°C...+60°C
Drag chain-application	2 Mio. cycles
Halogen-free	Yes
Torsion	+/-180°/m, < 1 Mio. cycles
Rated voltage cable	≤300 V
Special features	flame retardant, halogen free, hydrolysis proof, LABS free, oil resistant, ozone resistant, recyclable, RoHs compliant, acid- and alkali resistant, drag chain-adapted, welding sparks resistant, seawater resistant, silicone free, torsion resistant, UV resistant

Classification

eCl@ss 6.0	27279218
eCl@ss 7.0	27279218
eCl@ss 8.0	27279218
eCl@ss 9.0	27060312
ETIM 5.0	EC001855
ETIM 6.0	EC001855

Accessories

Labels, Valve connector
<https://www.escha.net/en/products/standard/accessories-for-connectivity/8047109>

Fixing screw
<https://www.escha.net/en/products/standard/accessories-for-connectivity/8060907>

Link to product

<https://www.escha.net/en/products/standard/valve-connectors/8055747>