

M8, female, angled, 3 poles, M8, male, angled, 3 poles, shielded, sensor-/actuator cable

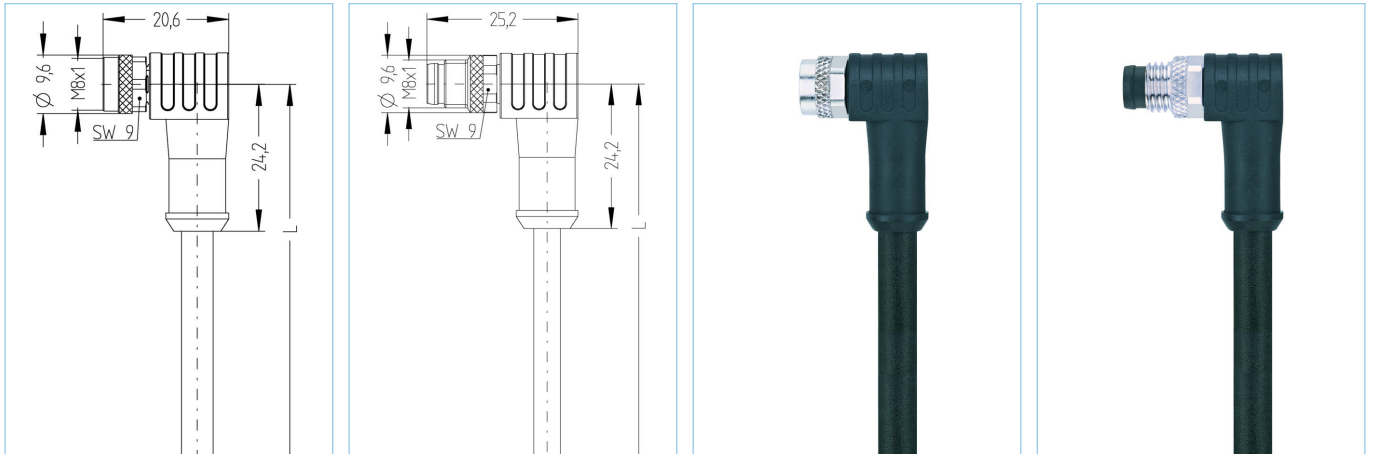

Product data

Item description	AL-SWKPS3-1-AL-SWSPS3/S370
Item-No.	8051919
Length	1m
Customs tariff-No.	85444290
Step-File	AL-SWKPS3_AL-SWSPS3.stp
EAN	4047106091996

Technical data	A-side	B-side
Connector	female, angled, M8	male, angled, M8
Number of pins	3	3
Pin assignment	1 BN, 3 BU, 4 BK	1 BN, 3 BU, 4 BK
Rated voltage	60V	60V
Current load (at 40°C)	4A	4A
Insulation resistance	$\geq 10^9 \Omega$	$\geq 10^9 \Omega$
Resistance	$\leq 5 m\Omega$	$\leq 5 m\Omega$
Ambient temperature product	-30°C...+90°C	-30°C...+90°C
Contact material	Metal, CuSn, gold-plated	Metal, CuSn, gold-plated
Contact-carrier material	Plastic, TPU, BK	Plastic, TPU, BK
Grip body material	Plastic, TPU, BK	Plastic, TPU, BK
Coupling nut material	Metal, CuZn, nickel-plated	Metal, CuZn, nickel-plated
Sealing (female) material	FPM/FKM	
Shielding	with shielding	with shielding
Standards	IEC 61076-2-104	IEC 61076-2-104
Degree of protection (mounted)	IP65, IP67, IP68	IP65, IP67, IP68
Mechanical life-cycle	>100 mating cycles	>100 mating cycles
Degree of pollution	3	3

Cable web PUR, UL, S370

Flexible, silicone- and halogen-free control cable with high mechanical strength. The cable is chemicals, hydrolysis-, and microbes-resistant. The drag-chain application is possible at a bending radius of minimum $10 \times d$. Due to its weld-field immunity, the cable is very well suited for the flexible application in robotics, machine-tool, and metal-cutting production. The cables meet the UL and CSA (UL10493/20549; cULus) requirements. Very good EMC-features with shielded versions.

Outer diameter of jacket	4.40 mm
Cable-jacket material	PUR
Jacket color	BK, similar RAL9005
Wire cross-section	3 x 0.25 mm ²
Wire insulation material	PP
Wire colors	BN, BU, BK
Wire structure	32 x 0.10 mm
Bending radius (fixed)	5 x Ø-cable
Bending radius (repeated)	12 x Ø-cable
Temperature range (repeated)	-30°C...+90°C
Temperature range (fixed)	-40°C...+90°C
Temperature range (drag chain)	-25°C...+60°C
Drag chain-application	5 Mio. cycles
Shielding	Yes
Halogen-free	Yes
Torsion	+/-360°/m, ≥ 2 Mio. cycles
Rated voltage cable	≤300 V
Special features	flame retardant, halogen free, hydrolysis proof, LABS free, oil resistant, ozone resistant, recyclable, RoHs compliant, acid- and alkali resistant, drag chain-adapted, welding sparks resistant, seawater resistant, silicone free, torsion resistant, UV resistant

Classification

eCl@ss 6.0	27279218
eCl@ss 7.0	27279218
eCl@ss 8.0	27279218
eCl@ss 9.0	27060311
ETIM 5.0	EC001855
ETIM 6.0	EC001855

Accessories
Mounting-clip, M8

<https://www.escha.net/en/products/standard/accessories-for-connectivity/8047658>

Torque-wrench set

<https://www.escha.net/en/products/standard/accessories-for-connectivity/8055431>

Marking rings Ø 9mm

<https://www.escha.net/en/products/standard/accessories-for-connectivity?p=1&o=3&n=15&f=809>

Screw plug, M8

<https://www.escha.net/en/products/standard/accessories-for-connectivity/8081771>

Screw cap, M8

<https://www.escha.net/en/products/standard/accessories-for-connectivity/8081761>

Link to product

<https://www.escha.net/en/products/standard/sensoractuator-connectors/8051919>