

Valve connector, housing style A, 2+PE bridged, varistor, sensor-/actuator cable

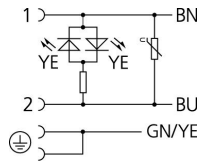
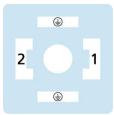
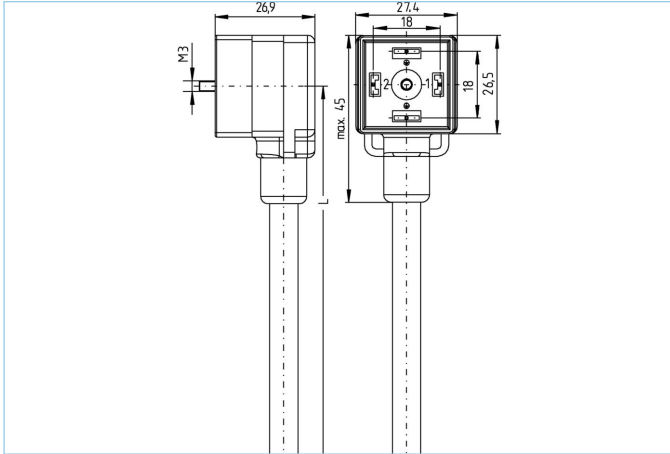

Product data

Item description	VA22-230.5-5/P00
Item-No.	8048819
Length	5m
Customs tariff-No.	85444290
Step-File	VA22.stp
EAN	4047106008758

Technical data

Connector	female, angled, Valve A
Number of pins	2+PE, PE bridged
Pin assignment	1 BN, 2 BU, PE: GNYE
Rated voltage	230V _{AC/DC}
Current load per pin (at 40°C)	4A
Insulation resistance	≥10 ⁹ Ω
Ambient temperature product	-30°C...+90°C
Signal status-indicator	LED YE
Contact material	Metal, CuZn, silver-plated
Contact-carrier material	Plastic, PA, BK
Grip body material	Plastic, TPU, BK, translucent
Sealing (female) material	Plastic, TPU
Protection circuit	Varistor
Fixing screw	Metal, CuZn, nickel-plated
Housing style	A
Standards	DIN EN 175301-803
Degree of protection (mounted)	IP65, IP67, IP68
Mechanical life-cycle	>100 mating cycles
Degree of pollution	3
Style	angled

Cable web PVC, P00, GY

PVC-cable for measurement and control-, and sensor technology. Suitable for applications in dry areas on packaging machines, assembly- and conveyor technology. High flexibility with unstressed movement (conditional drag-chain application possible). Predestined for applications in food- and beverage industry.

Outer diameter of jacket	6.2 +/- 0.1 mm
Cable-jacket material	PVC
Jacket color	GY, similar RAL7040
Wire cross-section	3 x 0.75 mm ²
Wire insulation material	PVC
Wire colors	BN, BU, GNYE
Wire structure	24 x 0,20 mm
Bending radius (fixed)	5xØ-cable
Bending radius (repeated)	10 x Ø-cable
Temperature range (repeated)	0°C...+80°C
Temperature range (fixed)	-25°C...+80°C
Rated voltage cable	240 V
Special features	good resistance against oils and chemicals, LABS free, ozone resistant, recyclable, RoHs compliant, acid- and alkali resistant, seawater resistant, UV resistant

Classification

eCl@ss 6.0	27279218
eCl@ss 7.0	27279218
eCl@ss 8.0	27279218
eCl@ss 9.0	27060312
ETIM 5.0	EC001855
ETIM 6.0	EC001855

Accessories

Labels, Valve connector

<https://www.escha.net/en/products/standard/accessories-for-connectivity/8047110>

Fixing screw

<https://www.escha.net/en/products/standard/accessories-for-connectivity/8060907>

Link to product

<https://www.escha.net/en/products/standard/valve-connectors/8048819>